

# tech

Designed lighting tools with focus on high efficiency combined with excellent light output.

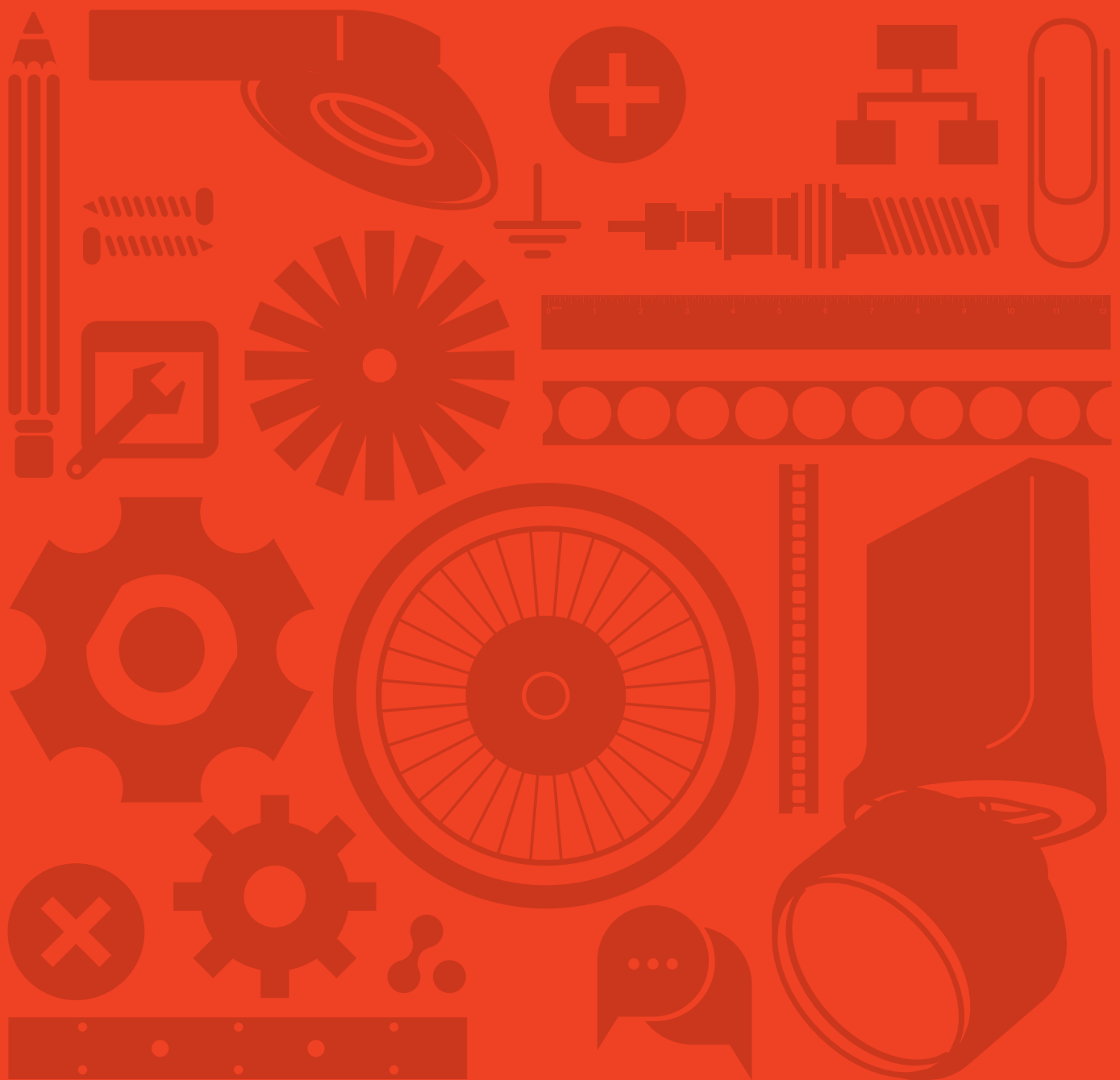

# focus on efficiency

Building on a history of strong design of architectural lighting for the domestic market, Delta Light® has grown to become a market leader in lighting for commercial and public spaces.

With the launch of The Lighting Bible® 10, the comprehensive product catalogue of Delta Light®, the company focused on extending its range of energy efficient lighting solutions. These new luminaires stand out with their exceptional performance, without compromising the credo of creative design of Delta Light®.

**04** R&D Quality / Design

**06** LED / Sustainability / Optics

**14** You-Turn

**08** iMax®

**18** Streamer

**22** Booster

**26** Headliner

**30** Grid In \* HP / HIC / Opto

**34** Supernova

**38** Logic

**42** 10 to look for in the Lighting Bible® 10

**44** Service & Solution driven

**46** Worldwide

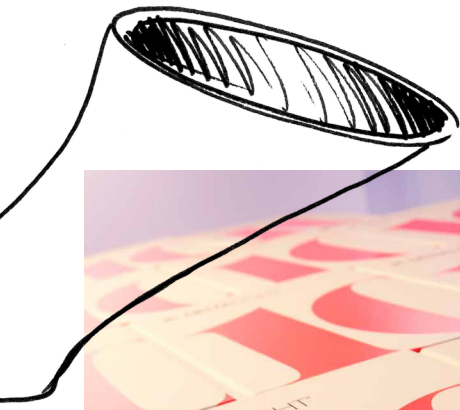

# R&D

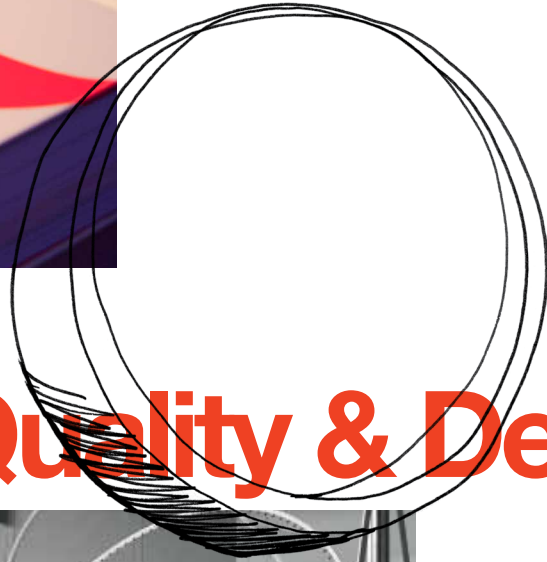

# Quality & Design

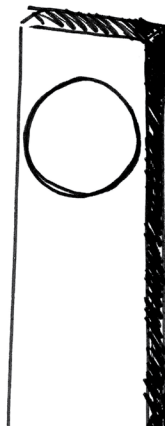
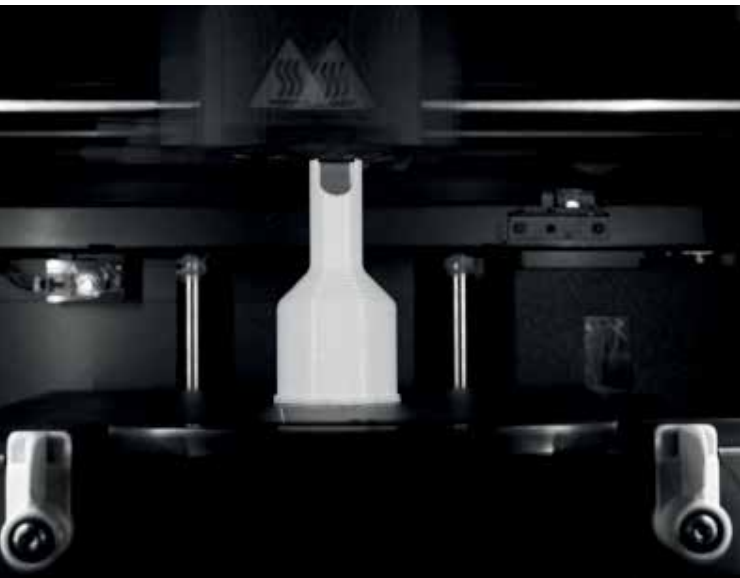

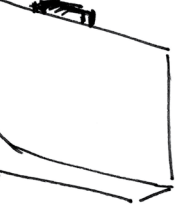

### Quality & testing

Throughout the entire production process Delta Light® distinguishes itself by handling the strictest quality parameters, to ensure products and services are designed and produced to exceed customer requirements. Every step in the production process has a routine quality control procedure, covering both product material quality and electrical testing. Each product that leaves Delta Light® has been inspected and tested thoroughly, resulting in minimal returns and maximum customer satisfaction.

Product quality and safety testing according to the international IEC standards is done in our own Delta Light® Laboratory which is accredited by SGS-CEBEC, achieving CE, ENEC and CB certifications for Europe and IEC member countries (<http://members.iecee.org/>). The laboratory also covers the testing of products for the North American market by being certified as a level 4 laboratory for INTERTEK. This allows us to easily obtain the cETLus listing for our products.



### In-house design

An essential piece of creative process at Delta Light® is the extensive in-house design, development, testing, engineering and manufacturing of all products. This enables the company to realize its short idea-to-market philosophy, resulting in extensive new collections on a very regular basis.

The extensive R&D team at Delta Light® ' is constantly on the look-out for the trends of the future, both in terms of design and use of materials, without losing sight for the power of imagination. The Delta Light® creative statement is recognised by several expert panels, resulting in a number of prestigious awards such as IF Design Award, Good Design Award, Red Dot Design Award and many others.

An important feature in the creative process of Delta Light® is use of state of the art development techniques. 3D printing, early stage FMEA (Failure Mode and Effect analysis) and in-house testing result in a fast, cost effective results in a first time right development process.

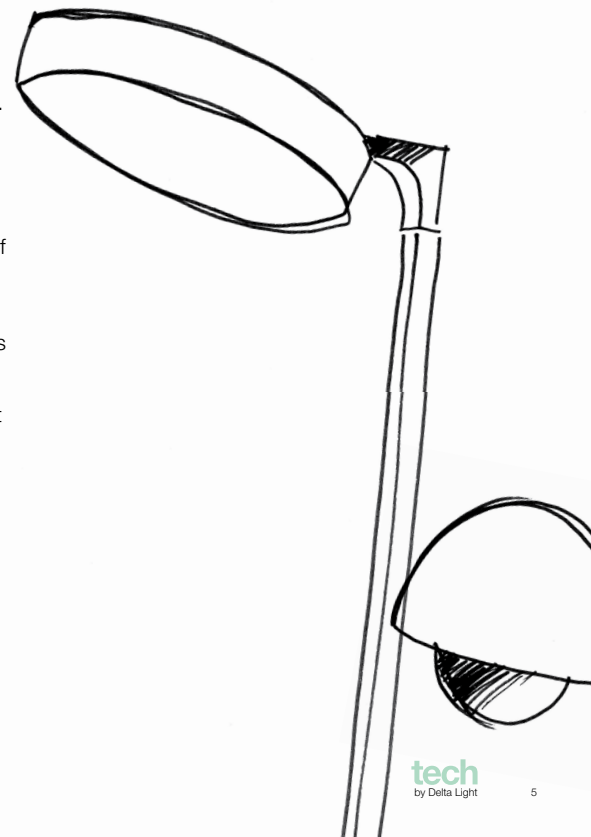



# LED

The continued advancement in LED technology provides new opportunities for energy-efficient lighting. Delta Light® plays a leading role in implementing this new technology, designing and manufacturing its own LED lamps, developing innovative LED products and tailor-made solutions.

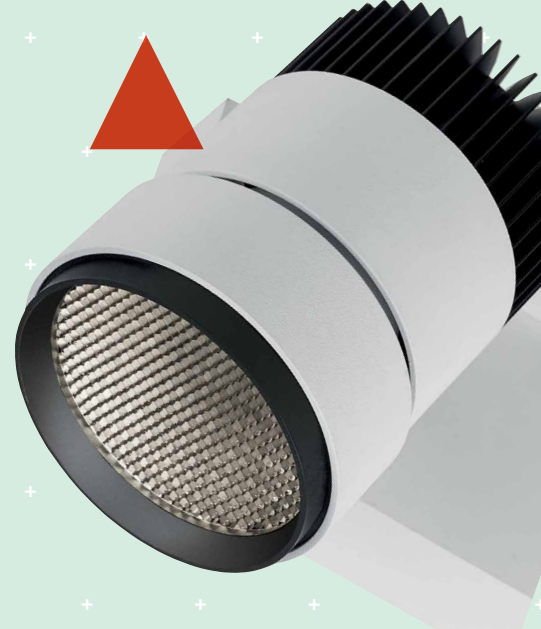

# Optics

## Optical performance

The team of engineers at Delta Light® are on a continuous quest to match the company's credo for design with energy-efficiency and optimal quality of light. Through extensive in-house testing, a vast knowledge and experience of product development and continuous optimisation of materials used, Delta Light® is able to provide architectural lighting that take the lead in optical performance, durability and efficiency.

- + The collection enables designers to create different lighting scenes, effect lighting such as accentuation and ambience, wallwashing, orientation or open area lighting by using the extensive selection of beams, filters, lenses and other accessories.



# Sustainability

The real measure of cost goes beyond just the initial cost of purchase, but also includes intelligent lighting control, lifetime expectancy, ease of maintenance and operational costs. Combining extensive product knowledge with a vast range of energy efficient product solutions and industry specific experience, Delta Light® is able to guide you through to a green, cost-effective and sustainable selection process - without compromising the quality of light.



# iMAX®

## SOFT CEILING

**The iMax® range is the first collection in the Soft Ceiling® concept. The name stands for maximum eye comfort - and minimal visual appearance, offering a vast range of high performing and discrete lighting solutions.**

The Delta Light® iMax® range is developed for low glare and as an easy tool for lighting design. The deeply recessed light source combines a discreet appearance with a controlled and precise light effect.



### **Best lighting quality**

The iMax® Soft Ceiling® range is using the most advanced LED engines available, delivering high performance, maximum efficacy and high quality illumination. The collection features different colour temperatures, CRI and output levels, combined with optimal colour consistency.

Throughout all versions specially designed reflectors guarantee uniform illumination and optimal beam alignment. Premium lenses are used to obtain real spot optics and best industry accuracy and quality.

### **Wet locations**

The fixed and adjustable versions in the range are available with a clear glass, offering IP54. This enables you to continue the Soft Ceiling® minimalism and uniformity throughout bathrooms, wellness areas and other indoor damp locations.

### **Less is more**

The Soft Ceiling® concept focuses on minimal appearance, giving stage to the light instead of the fixture. As such, the collection merges Delta Light's credo for design sophistication and eye for detail, with precise engineering and premium materials, resulting in minimal fixtures with maximum impact. The interchangeable covers and colour finishes allow you to apply luminaires that disappear into the background.

CLEAN  
SIGHTLINES  
MINIMAL  
APPEARANCE  
MAXIMUM EYE  
COMFORT  
GLARE-FREE  
ONE LUMINAIRE  
TYPE FOR  
MULTIPLE  
LIGHTING  
SCENOGRAPHIES





**The Soft Ceiling® concept enables you to create discrete but varied lighting scenography, using one luminaire type. It allows architects and designers to work with different lighting applications, beams, effects, filters and output levels, using unobtrusive and glare-free fixtures for a zero-sightline ceiling.**

Thanks to precise engineering, the use of superior reflector materials and a multitude of options, Soft Ceiling® fixtures guarantee optimal optic performance and maximum eye comfort. The vast range of options allow you to work with a Soft Ceiling® luminaire throughout the entire project, meeting the different needs of each room, without unnecessary cluttering of the ceiling.



**iMax® / 4 beams / Extreme Narrow (SP-6°), Narrow (SP-10°), Medium (FL-29°) and Wide (WFL-43°)**



**iMax® Adjustable - Trimless / 4 beams / Extreme Narrow (SP-6°), Narrow (SP-10°), Medium (FL-29°) and Wide (WFL-43°)**



**iMax® Wallwash / 2 beams / Medium (FL-29°) and Wide (WFL-43°)**

**Lots of Options**

The **iMAX®** collection is a wide range of minimal recessed light fixtures, combining a discrete presence with high quality results. You can choose from fixed or **adjustable, trimless or with trim, and a wallwash version**, each one available with different light sources and finishes. There is also a choice of IP rated fittings in the different models. While the wallwasher comes in LED only, the other three versions can be equipped with either LED, halogen or discharge lamps. Opting for LED opens a wide array of possibilities with lumen packages ranging from 400 to 2000 lumens and with beam angles starting at 6 degree going to 43. This new product range enables architects and designers to do their own lighting design, made easy by using the iMax as a toolbox with different beam angles and accessories.

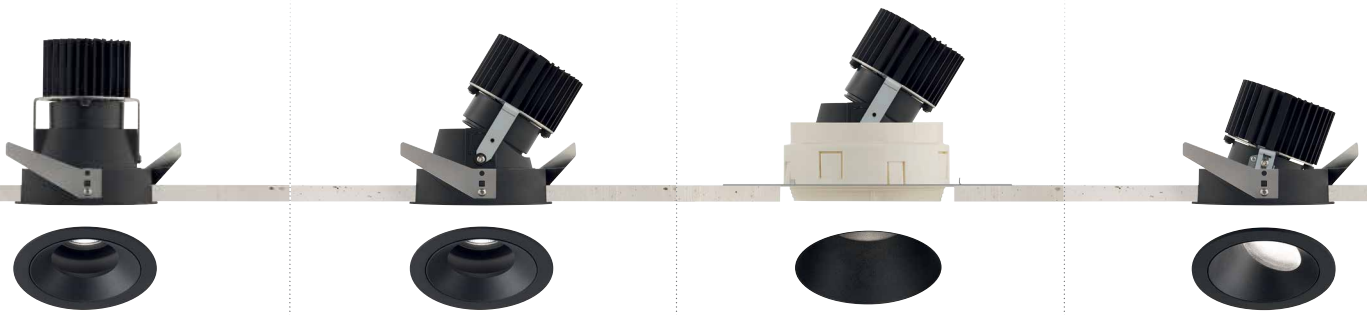

**iMAX® ADJUSTABLE**

A versatile accent lighting solution. For emphasising of individual objects or architectural elements. The tilt mechanism which allows the luminaire to be angled up to 30° is engineered with precision for optimum beam alignment. As a result, the light is emitted exactly where it's needed. The tilting indicator and double locking system enable precise alignment of multiple fixtures.

**30°  
ADJUSTABLE  
& LOCKABLE**



**iMAX® ADJUSTABLE TRIMLESS**

Ultimate minimalism combined with maximum eye comfort. This version comes with a trimless mounting kit enabling quick and precise installation and finishing. The interchangeable black, white or gold insert allows you to match the fixture with its surroundings and sets the mood of the light; gold for extra warmth, black further reducing glare. A smooth finish matched with maximum lighting comfort.



**iMAX® WALLWASH**

The high performance soft ceiling® wallwasher creates evenly illuminated walls. The especially designed reflector enables uninterrupted and homogenous illumination of the wall, from floor to ceiling. To obtain best result, follow the recommended spacing and set out from the wall.

**iMAX®**  
Uniform light for general, glare-free illumination for all areas of application. A discrete appearance combined with a multitude of options, including different beams, outputs, colour temperatures, CRI and colour finishes. A timeless, highly functional and unobtrusive architectural lighting tool.

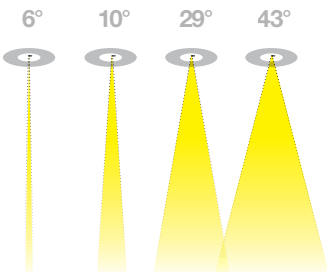

**One cut-out for multiple versions:**  
Fixed / Adjustable / Wallwash



Optimal cooling for 400, 800, 1300 or 2000Lm, respecting minimal recessed depth.

Using advanced led engines, delivering high performance, maximum efficacy and high quality illumination. Available in different colour temperatures, CRI and output levels. Color Consistency 2SDCM / 3SDCM

Wide range of lenses and reflectors available, guaranteeing uniform illumination in extreme narrow, narrow, medium and wide beams.

Double locking system enables fixation of both tilting and fixture position, for perfect alignment of multiple fixtures.

Range of light shaping and glare controlling accessories available, combining maximum eye comfort, full beam control and minimal light loss. Up to 2 accessories can be combined in 1 fixture.

Fixed and adjustable versions available with clear glass IP54

Interchangeable round or square front cover, available in white, black and gold combinations. These covers are characterized by a slender trim, or can be installed flush to the ceiling for a super smooth finish, fading into its surroundings.





# iMAX<sup>®</sup> COVERS & ACCESSORIES

for iMax / iMax Adjustable / iMax Adjustable Trimless

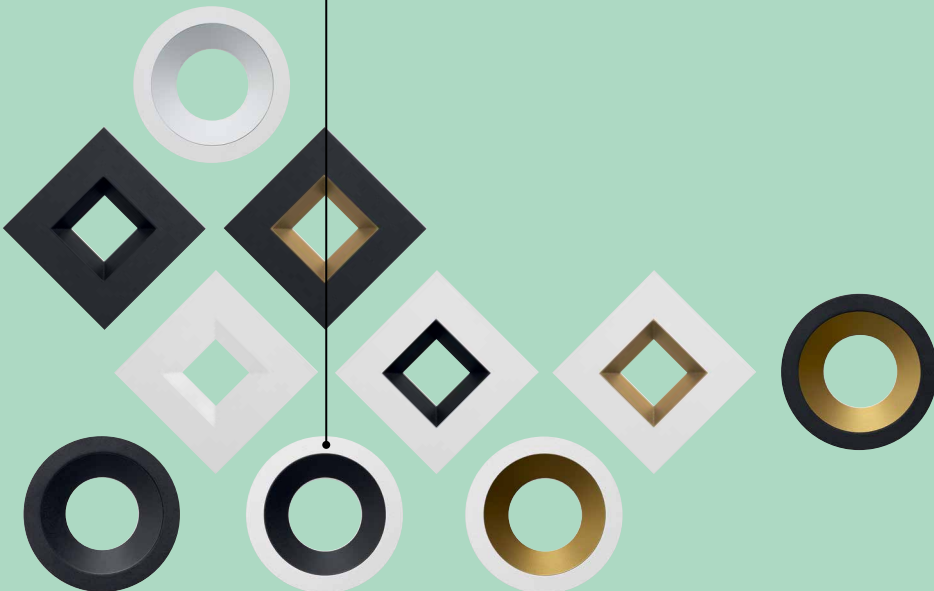

## LED

iMAX® \_\_\_\_\_ 401 \_ \_ \_ \_ \_  
 iMAX® ADJUSTABLE \_\_\_\_\_ 402 \_ \_ \_ \_ \_  
 iMAX® ADJUSTABLE TRIMLESS \_\_\_\_\_ 403 \_ \_ \_ \_ \_  
 iMAX® WALLWASH \_\_\_\_\_ 404 \_ \_ \_ \_ \_

### LED

- 01 08 BRIDGELUX REFLECTOR 800
- 01 20 BRIDGELUX REFLECTOR 2000 (NOT FOR WALLWASH)
- 02 04 BRIDGELUX LENS 400 (NOT FOR WALLWASH)
- 11 13 XICATO REFLECTOR 1300
- 22 02 CREE LENS (NOT FOR WALLWASH)

### CRI

- 8 CRI>80
- 9 CRI>90 (XICATO CRI>95)

### COLOUR TEMPERATURE

- 2 2700K ●
- 3 3000K ●
- 4 4000K ● (ON REQUEST)

### BEAM ANGLE

- 9 SPOT (ONLY FOR LENS-TYPES)
- 1 FLOOD (ONLY FOR REFLECTOR-TYPES / EXCEPT XICATO)
- 2 WIDE FLOOD (ONLY FOR REFLECTOR-TYPES)

## HALOGEN / DISCHARGE

iMAX® \_\_\_\_\_ 401 60 00 HALOGEN 12V  
 401 61 00 HALOGEN GU10 (MAINS VOLTAGE)  
 401 80 00 DISCHARGE

iMAX® ADJUSTABLE \_\_\_\_\_ 402 60 00 HALOGEN 12V  
 402 61 00 HALOGEN GU10 (MAINS VOLTAGE)  
 402 80 00 DISCHARGE

iMAX® ADJUSTABLE TRIMLESS\* \_\_\_\_\_ 403 60 00 HALOGEN 12V  
 403 61 00 HALOGEN GU10 (MAINS VOLTAGE)  
 403 80 00 DISCHARGE

REQUIREMENT REFERENCE \_\_\_\_\_ 400 00 \_ \_ \_ ◇

### COVER

- 11 ROUND (NOT IN COMBINATION WITH TRIMLESS & WALLWASH)
- 19 ROUND FLUSH (NOT IN COMBINATION WITH TRIMLESS & WALLWASH)
- 21 ROUND IP (NOT IN COMBINATION WITH TRIMLESS & WALLWASH)
- 41 ROUND WALLWASH (ONLY FOR WALLWASH)
- 55 SQUARE (NOT IN COMBINATION WITH TRIMLESS & WALLWASH)
- 30 ROUND TRIMLESS (ONLY FOR TRIMLESS)

### COLOUR

- B-B BLACK-BLACK
- B-MMAT BLACK-GOLD MAT
- W-B WHITE-BLACK
- W-MMAT WHITE-GOLD MAT
- W-W WHITE-WHITE
- B BLACK (ONLY FOR TRIMLESS)
- MMAT GOLD MAT (ONLY FOR TRIMLESS)
- W WHITE (ONLY FOR TRIMLESS)

# You Turn

The You-Turn is a pioneering lighting system that allows comprehensive illumination alternatives, in combination with timeless design and outstanding comfort of use. As the name of the fixture indicates, the user is free to turn and play with it whenever and however needed. The body of the You-Turn can be tilted in a 90° angle, and rotated no less than 350°.

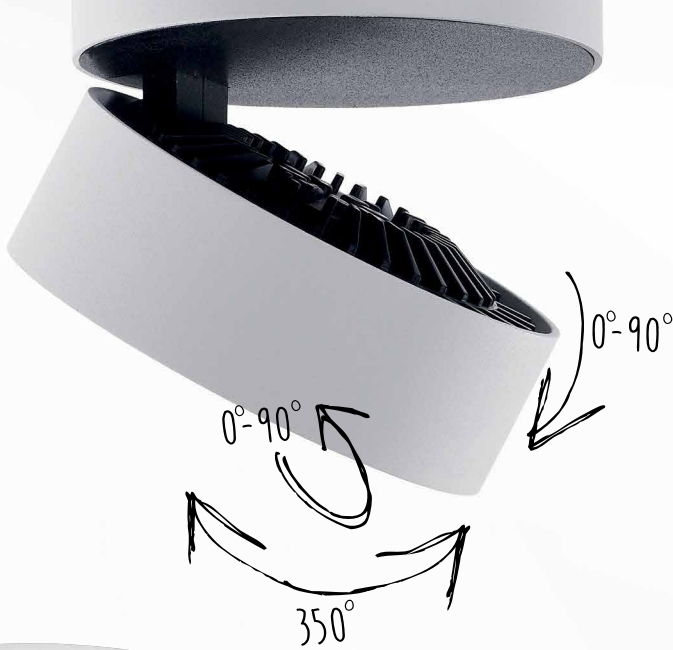

Excellent colour rendering (CRI 80 / 90), colour quality & colour consistency.

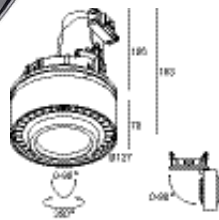

## YOU-TURN OPTO

Led specific optic improves performance and efficiency with 15% (vs Reo). Combining the Equalising Filter Technology with specially designed cooling system provides optimal optic performance, comfort and extended durability, with 2000 lumen dimmable LED.

LUX		CRI 80		CRI 90	
		2700K	3000K	2700K	3000K
0.5m	15°	44037	46837	37419	41237
	33°	15571	16561	13231	14581
	55°	7120	7573	6050	6668
1.0m	15°	11010	11710	9356	10310
	33°	3892	4140	3307	3645
	55°	1781	1894	1513	1657
1.5m	15°	4893	5205	4158	4582
	33°	1731	1841	1470	1621
	55°	790	840	671	740
2.0m	15°	2751	2926	2336	2577
	33°	973	1035	827	911
	55°	444	472	377	416

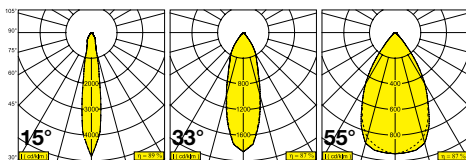

**YOU-TURN(O)N OPTO**  
Honeycomb and Softening lens available as light refining accessories.





**YOU-TURN ON REO**

Compact high flux LED solution that delivers uniform high quality illumination, without pixilation or multiple shadow effect. Dimmable 2000 lumen LED.

LUX		CRI 80		CRI 90	
		2700K	3000K	2700K	3000K
0.5m	33°	13169	14957	11949	14063
	50°	7590	8073	6449	7107
1.0m	33°	3291	3738	2986	3515
	50°	1899	2019	1613	1778
1.5m	33°	1463	1661	1327	1562
	50°	843	897	716	790
2.0m	33°	823	935	747	879
	50°	475	505	403	444

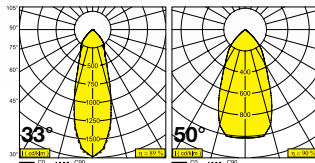

To complete the **fully integrated architectural lighting** solution the You-Turn can be combined with the Splitline 52 profile.



**YOU-TURN ON HIT**

Specially designed segmented reflector in sheet metal plate provides superior reflection abilities. Up to 93% efficiency thanks to use of advanced reflector material, guaranteeing reduced energy consumption. Available in spot 15°, flood 24° and wide flood 43° it can be applied for accent lighting and/or general lighting.

LUX		35W		70W	
		15°	24°	15°	24°
0.5m	15°	188914	383075	91665	91665
	24°	42034	19682	39911	39911
1.0m	15°	47228	95769	22916	22916
	24°	11301	4520	9887	9887
1.5m	15°	20990	42564	10185	10185
	24°	5623	2187	4435	4435
2.0m	15°	11807	23942	5739	5739
	24°	2625	1230	2484	2484

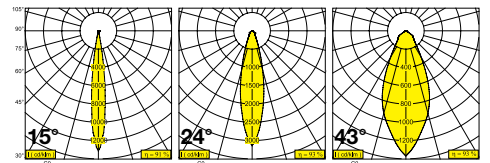

**Precise and high-quality lighting.**

The extensive You-Turn range allows you to cater for a wide variety of lighting needs, from narrow beam to wide flood.

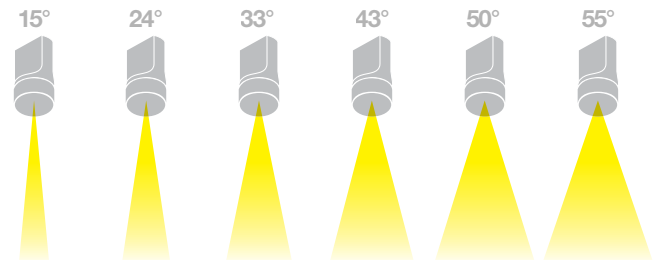







# You Turn

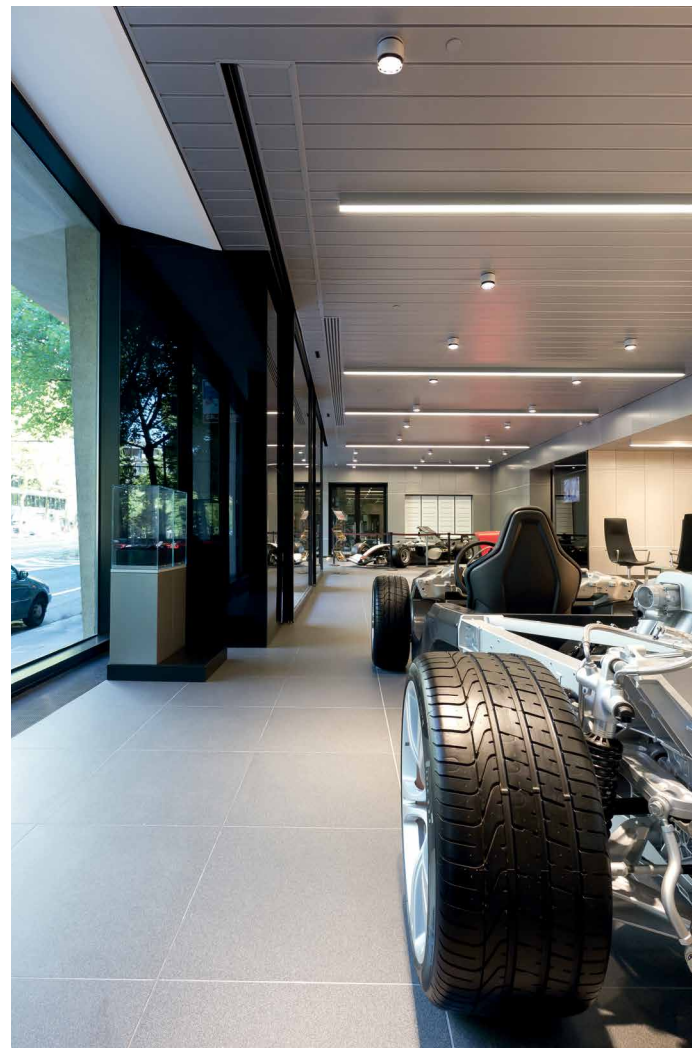



# Streamer

Streamer is a range of indoor LED recessed luminaires standing out because of their high light output ratio and visual comfort. The diversity of the Streamer range enables architects and lighting designers to modify the lighting distribution to suit specific lighting tasks. The Streamer wallwash offers a very even illumination when following the advised set out guide.

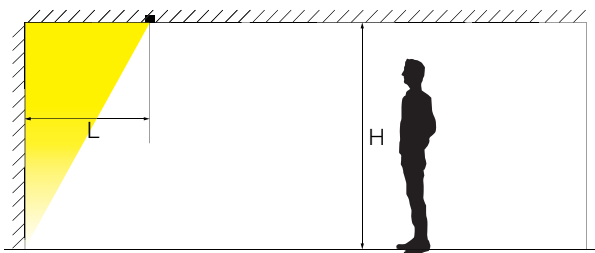

Formula  $L = H \times 0,35$

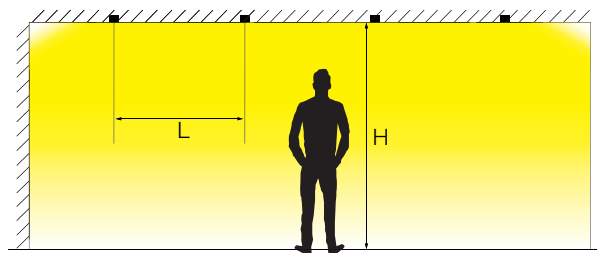

Formula  $L = H \times 0,35$

# Wallwash



**TRIMLESS W M ED1**  
INCL. 2 x POWERLED WHITE 7W  
3000K ●  
2 x 660lm

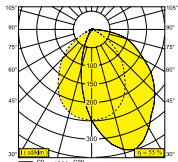
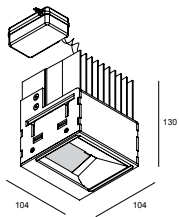

**TRIMLESS W L350 ED1**  
INCL. 3 x POWERLED WHITE 7W  
3000K ●  
3 x 660lm

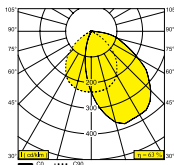
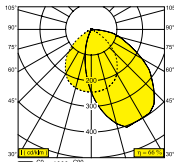
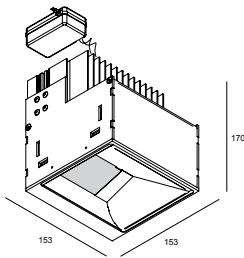

**W S ED1**  
INCL. 1 x POWERLED WHITE 10W  
3000K ●  
1 x 920lm

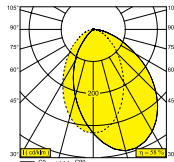
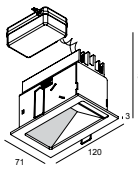

**W M ED1**  
INCL. 2 x POWERLED WHITE 7W  
3000K ●  
2 x 660lm

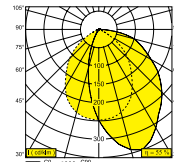
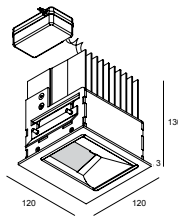

**W L350 ED1**  
INCL. 3 x POWERLED WHITE 7W  
3000K ●  
3 x 660lm

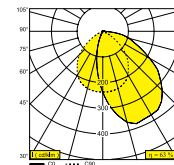
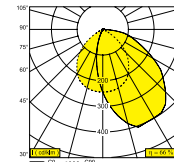
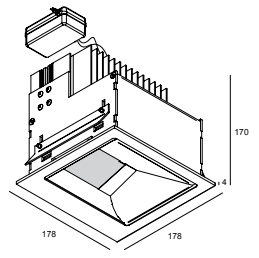

# Downlight



**TRIMLESS M ED1**  
INCL. POWERLED WHITE 10W  
3000K ●  
920lm

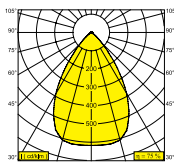
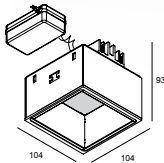

**TRIMLESS L ED1**  
INCL. LEDCLUSTER 27W  
3000K ●  
2300lm

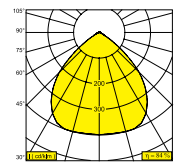
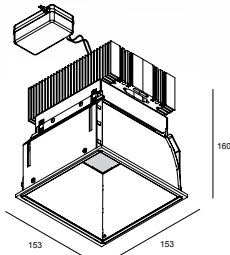

**M ED1**  
INCL. POWERLED WHITE 10W  
3000K ●  
920lm

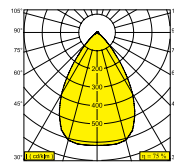
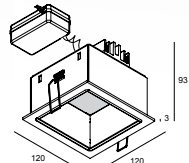

**L ED1**  
INCL. LEDCLUSTER 27W  
3000K ●  
2300lm

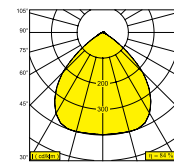
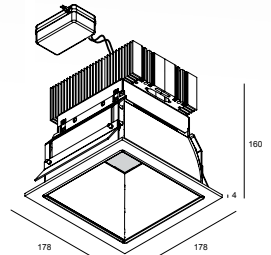

# Streamer Light Calculation

The project study below shows a  
Delta Light® / Light Calculation of the Streamer L

## FLOORPLAN

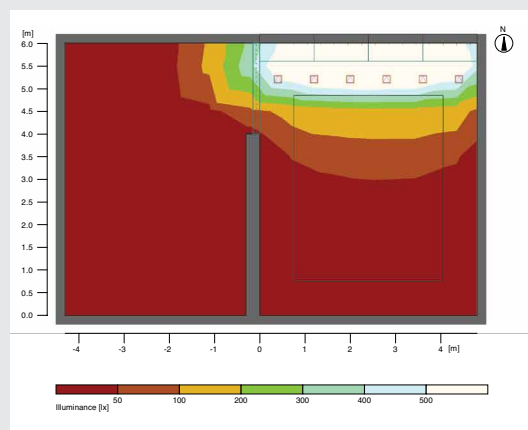

## LIGHT CALCULATION T16

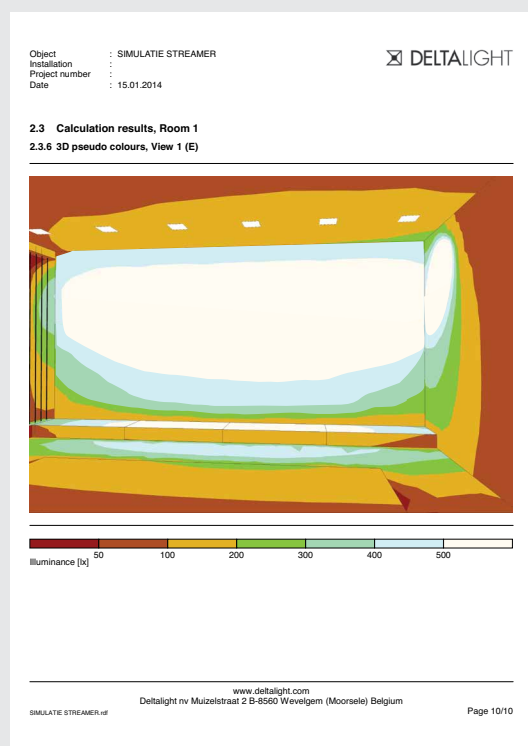

## 3D RENDER

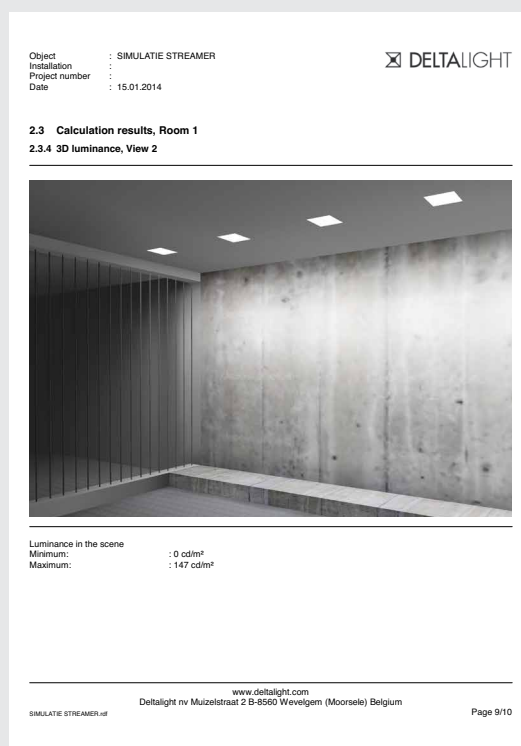



# Booster

The Booster was designed specifically for public buildings and commercial applications.

This extremely powerful and adjustable luminaire is available on adaptor for 3 circuit track system, or ceiling surface mounted. Lamp options are high intensity discharge lamps and different LED versions, including a powerful 3000 lm with different reflectors.

## led

Both the surface mounted and the adaptor version of the Booster are available with a 1500 lm and 3000 lm LED.

All Booster LED modules meet Zhaga standards, providing an even light emission surface created using CoB (Chip-on-Board) technology with excellent homogeneous characteristics.

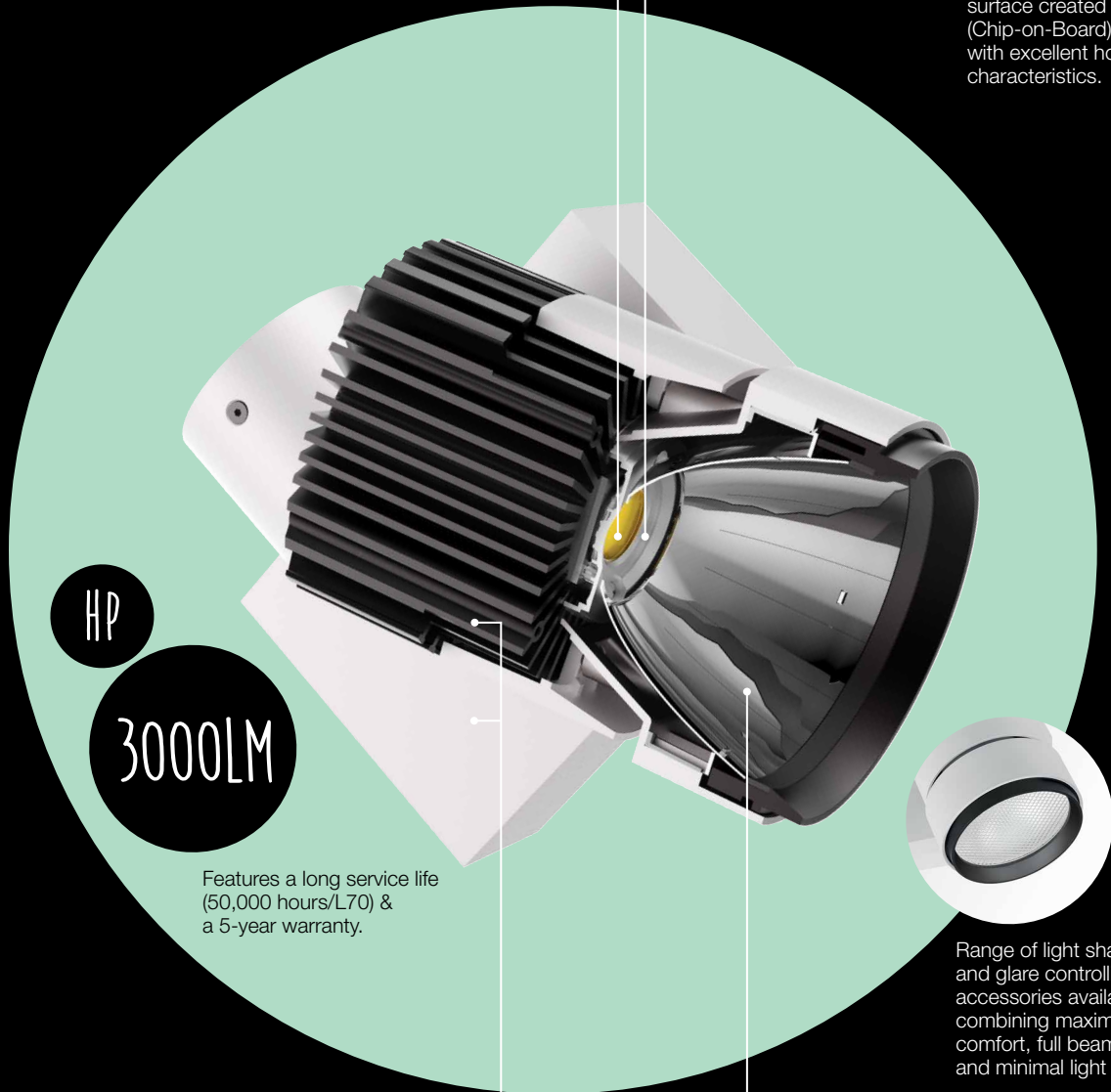

HP

3000LM

Features a long service life (50,000 hours/L70) & a 5-year warranty.

Range of light shaping and glare controlling accessories available, combining maximum eye comfort, full beam control and minimal light loss.

Up to 90% efficiency thanks to use of advanced reflector design, guaranteeing reduced energy consumption. Reflectors available from 18° up to 52°.

The intelligent connection of the LED module to the control gear gives the unit outstanding technical, electrical and thermal properties.

# Booster HP

UP TO  
**90%**  
EFFICIENCY

- 
- t
- led
- 1500LM
- 3000LM

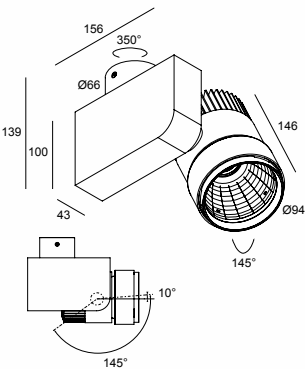
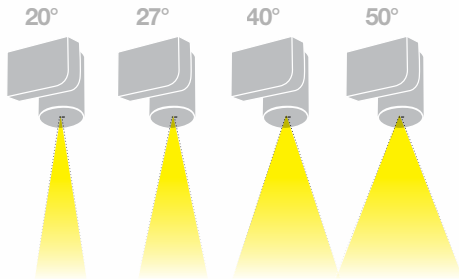
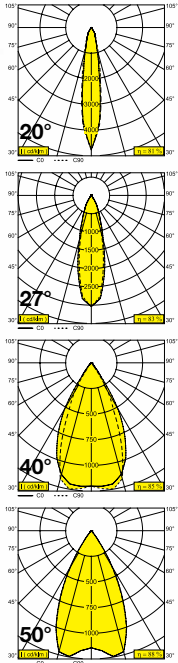

3000Lm

# Booster HIC

UP TO  
**90%**  
EFFICIENCY

- 
- t

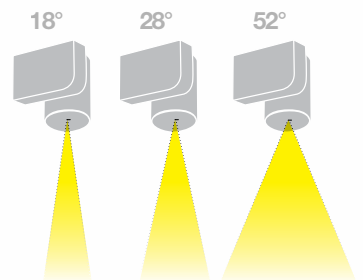
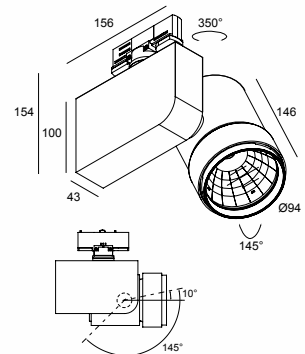
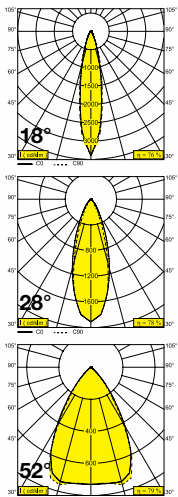

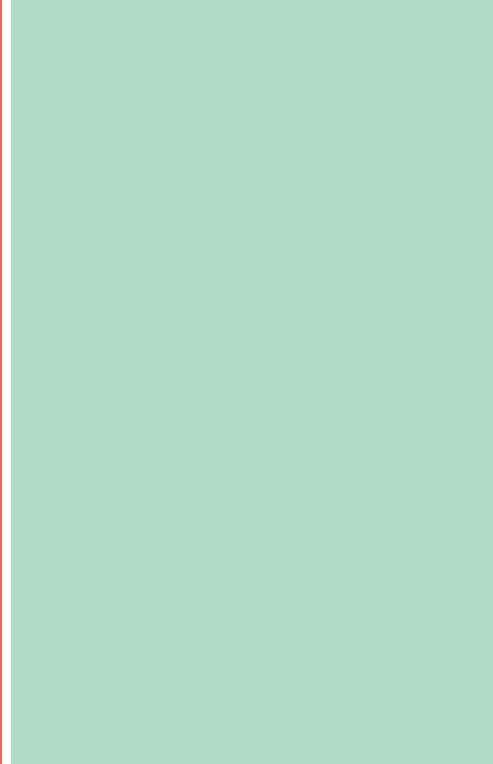

# Booster





11 5  
1

[4]

[3]

HBSU 100605 0  
12G1

MAX. 24000 kg  
GROSS 52910 lbs  
TARE 2130 kg  
4690 lbs  
NET 21870 kg  
48220 lbs  
CUBE 32.9 m  
1168 cft

# Headliner

The Headliner is a no-nonsense made-to-measure or ready-made profile solution, with superior efficiency and light output results. Pure light in homogeneously illuminated lines.

## An answer for every need

The Headliner profile can be used for general lighting to wallwash or accent lighting, from office to public, educational, retail and many other projects. It's vast range of modules and accessories allow you to integrate Headliner in high demanding environments.

Headliner enables you to create an endless line of light without shadows by use of LED or T16 fluorescent lamps, either seamless or by system with overlapping lamps. All light modules guarantee high efficiency, low energy consumption and ease of use.

## Applications

The Headliner is extremely diverse, enabling you to use one system throughout the entire project. Its versatility is an easy and intelligent answer to complex situations. Headliner can be used recessed, surface mounted or suspended.

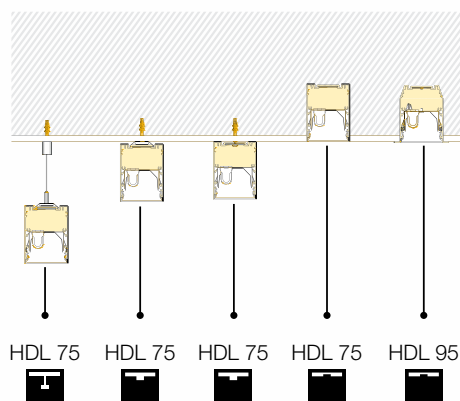

## Around the corner...

In addition to its top-class performance, the Headliner enables architects and lighting designers to easily take light around the corner.

The easy-to-use **L-modules** enable more options in creative design, connecting endless light lines in 90° angles, without compromise on the quality of light.

Structural design and room geometries can easily be defined, fusing light and architecture.

### HDL Corner 180°

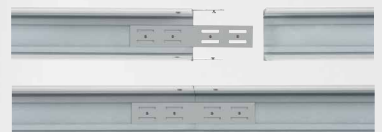

### HDL Corner 90°



# Focus on performance

In addition the standard version Delta Light® introduces the brand-new HE Reflector. An especially designed reflector in segmented sheet metal plate, providing new levels of energy efficiency. Adding the HE Reflector to the standard Headliner module leads to exceptional output results.

## Efficiency

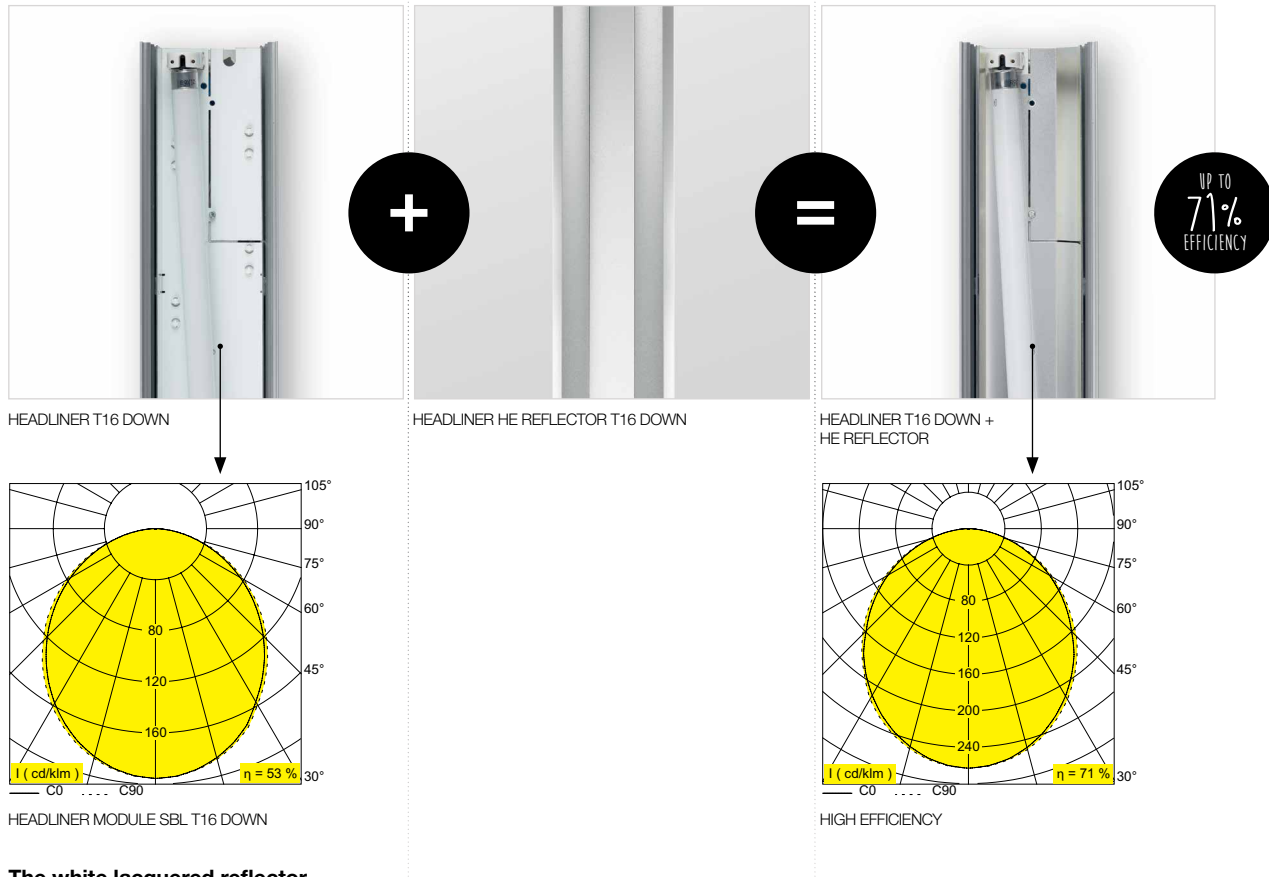

### The white lacquered reflector

of the standard Headliner is optimized to produce perfect lighting conditions.

+

### HE Reflector

Specially designed reflector in sheet metal plate provides superior reflection abilities. Resulting in increase of efficiency of 34%, guaranteeing reduced energy consumption.

=

Exceptional output results are achieved by adding the HE Reflector to the standard Headliner module, **resulting in 71% efficiency.**

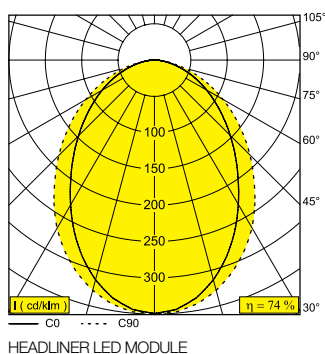

Endless line of light using 28 cm long LED arrays of 7.5W with an efficacy of 120 Lm/W resulting in 3214 Lm/m





# Headliner



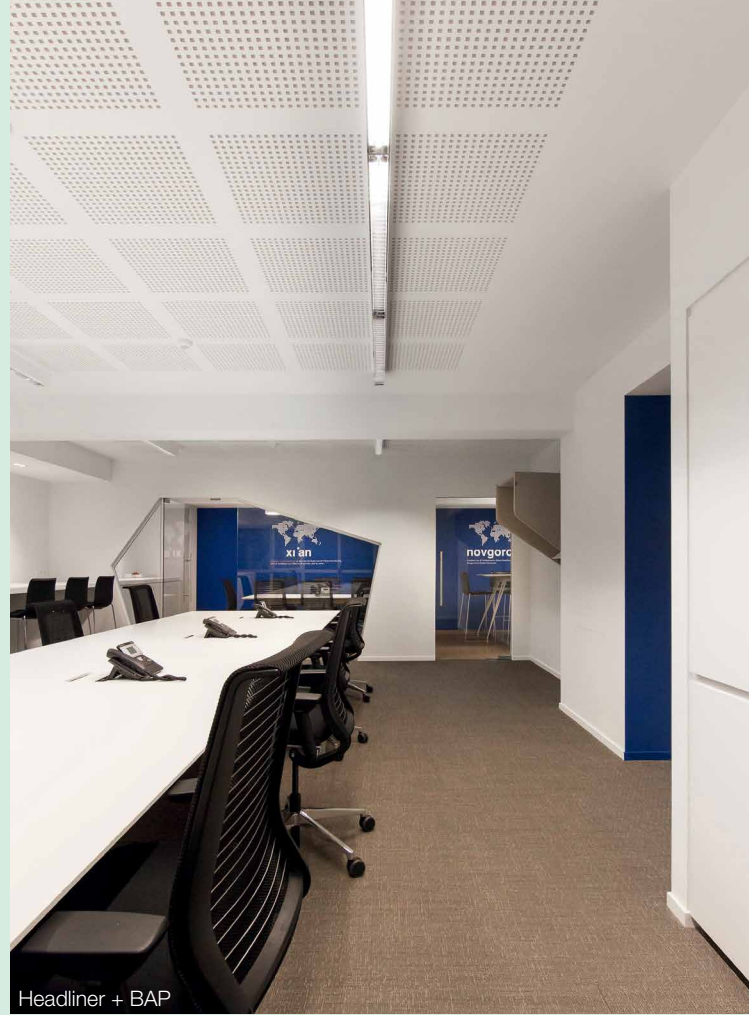

# Grid In\* HP/HIC

Over the years Delta Light® has developed a vast range of ceiling recessed luminaires in many different versions, catering for different types of projects.

The Grid product family is a longstanding classic in the collection. The latest versions added to the Grid downlight range stand out in energy efficiency and lighting quality.

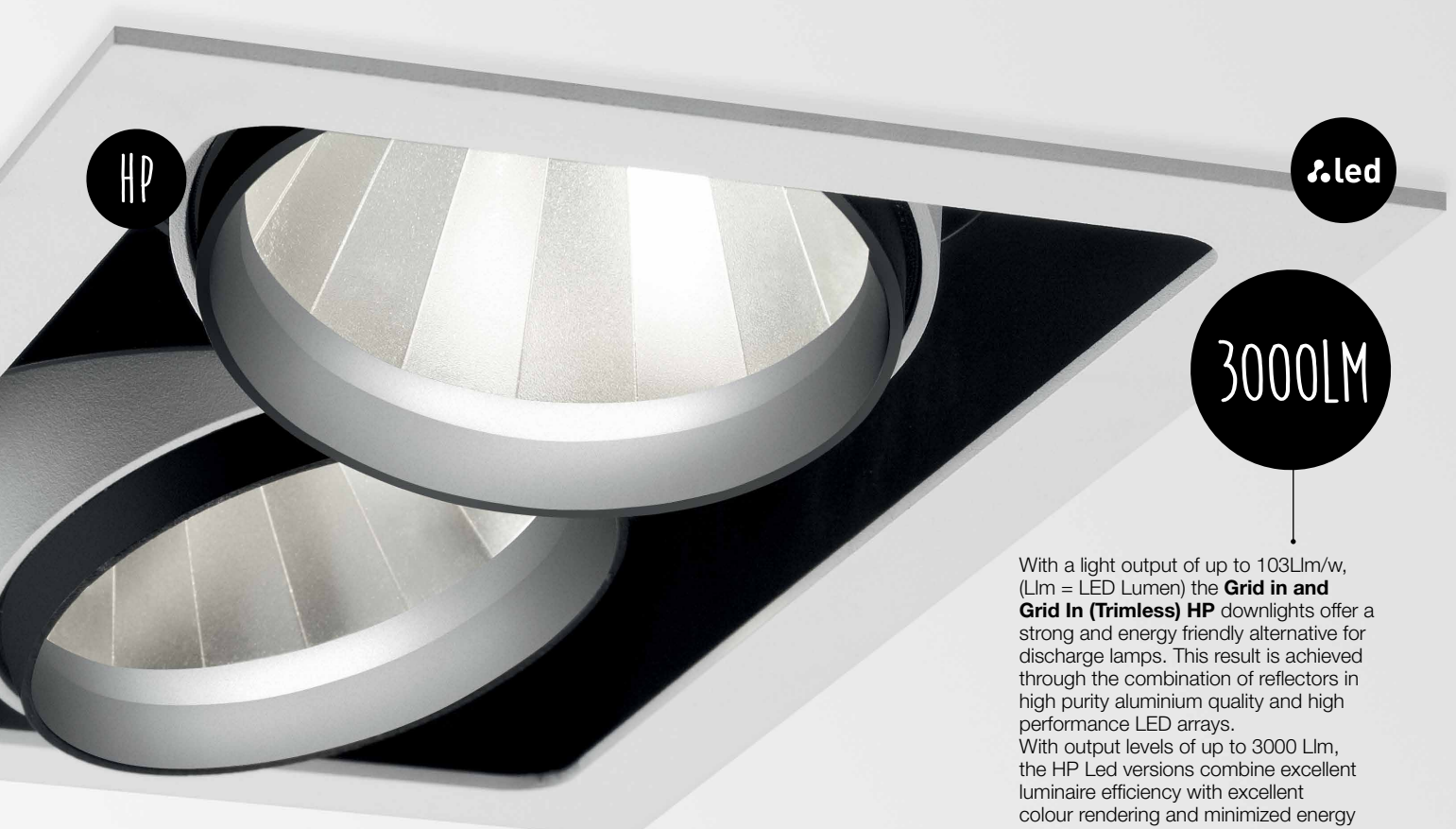

led

3000LM

With a light output of up to 103Llm/w, (Llm = LED Lumen) the **Grid in and Grid In (Trimless) HP** downlights offer a strong and energy friendly alternative for discharge lamps. This result is achieved through the combination of reflectors in high purity aluminium quality and high performance LED arrays. With output levels of up to 3000 Llm, the HP Led versions combine excellent luminaire efficiency with excellent colour rendering and minimized energy consumption.

HIC

Specially designed segmented reflector in sheet metal plate provides superior reflection abilities. Up to 93% efficiency thanks to use of advanced reflector material, guaranteeing reduced energy consumption. Available in spot 15°, flood 24° and wide flood 43°.



UP TO  
93%  
EFFICIENCY

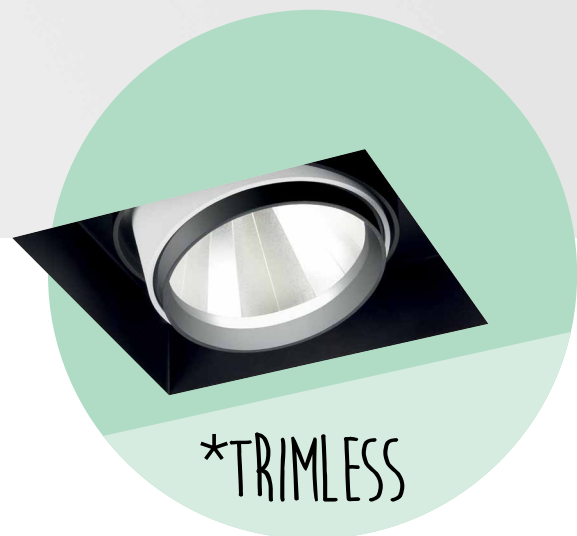

\*TRIMLESS

3000lm

# HP

UP TO 93% EFFICIENCY

# HIC

EFT

# Opto

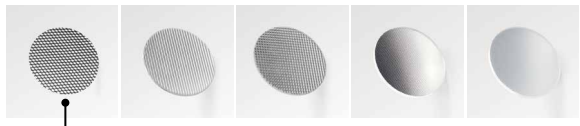
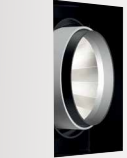

**led**  
**GRID IN TRIMLESS HP**  
 ADJUSTABLE 0-20° / 340°  
 INCL. 1 x POWERLED WHITE  
 3000K ● CRI80 3000lm (26W)  
 CRI90 3000lm (33W)  
 FL-27° / WFL-50°

**led**  
**GRID IN HP**  
 ADJUSTABLE 0-20° / 340°  
 INCL. 1 x POWERLED WHITE  
 3000K ● CRI80 3000lm (26W)  
 CRI90 3000lm (33W)  
 FL-27° / WFL-50°

**led**  
**GRID IN TRIMLESS HIC**  
 G8.5 / EXCLEVG  
 1 x HIT-TC max.70W  
 SP-15° / FL-24° / WFL-43°

**led**  
**GRID IN HIC**  
 G8.5 / EXCLEVG  
 1 x HIT-TC max.70W  
 SP-15° / FL-24° / WFL-43°

**led**  
**GRID IN TRIMLESS OPTO**  
 ADJUSTABLE 0-30°  
 INCL. 1 x POWERLED WHITE 18W  
 4000K ● ON REQUEST  
 3000K ● CRI80 1570lm / CRI80 1295lm  
 2700K ● CRI80 1475lm / CRI80 1284lm  
 SP-15° / FL-33° / WFL-55°

**led**  
**GRID IN OPTO**  
 ADJUSTABLE 0-30°  
 INCL. 1 x POWERLED WHITE 18W  
 4000K ● ON REQUEST  
 3000K ● CRI80 1570lm / CRI80 1295lm  
 2700K ● CRI80 1475lm / CRI80 1284lm  
 SP-15° / FL-33° / WFL-55°

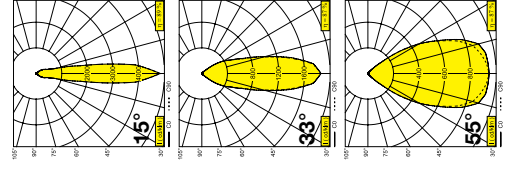
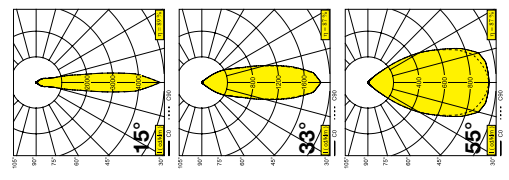
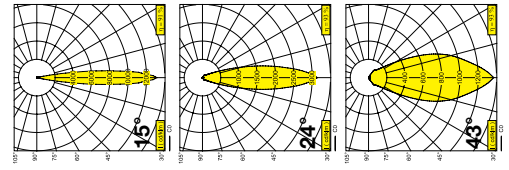
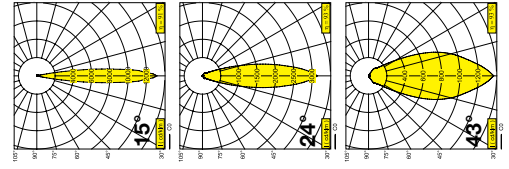
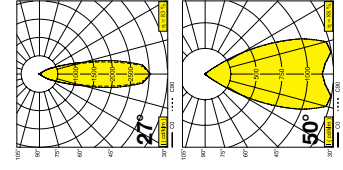
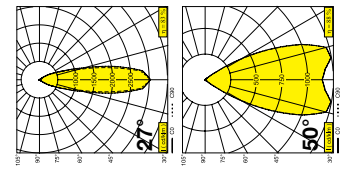
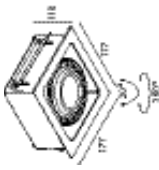
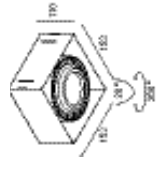
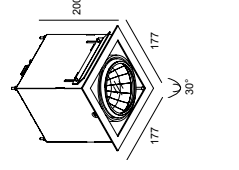
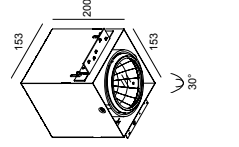
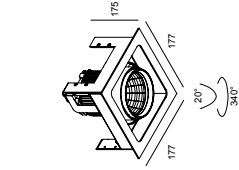
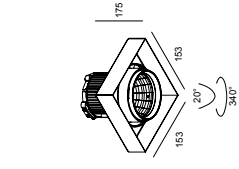

Interchangeable  
Honeycomb &  
Softening lens  
available.







# Supernova

In no time Supernova has become a classic in the Delta Light® collection. It's an extensive range of light fittings in pure geometric shapes with high light output that are guaranteed to contribute to atmosphere in any space.

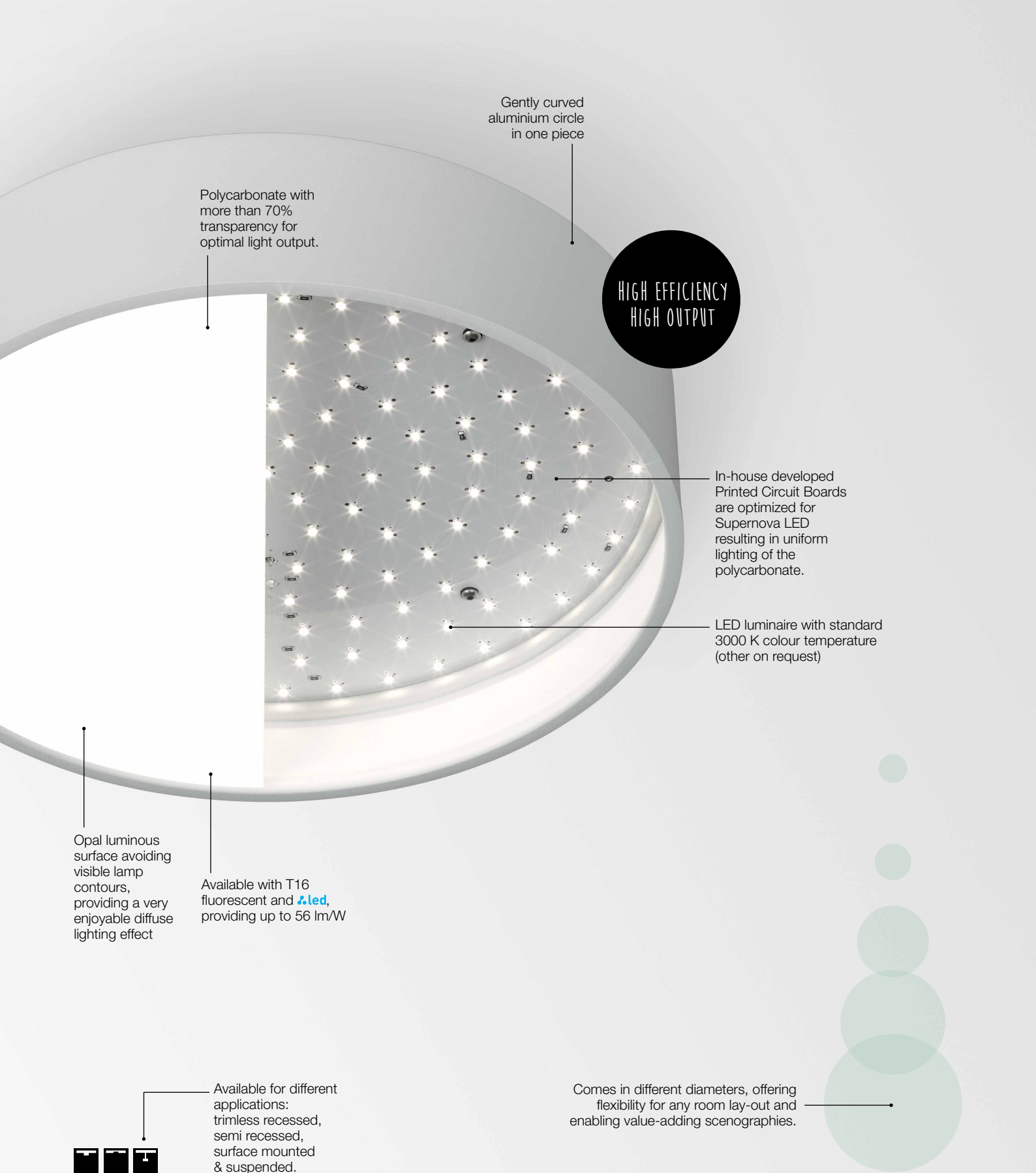

Gently curved aluminium circle in one piece

Polycarbonate with more than 70% transparency for optimal light output.

HIGH EFFICIENCY  
HIGH OUTPUT

In-house developed Printed Circuit Boards are optimized for Supernova LED resulting in uniform lighting of the polycarbonate.

LED luminaire with standard 3000 K colour temperature (other on request)

Opal luminous surface avoiding visible lamp contours, providing a very enjoyable diffuse lighting effect

Available with T16 fluorescent and **led**, providing up to 56 lm/W



Available for different applications: trimless recessed, semi recessed, surface mounted & suspended.

Comes in different diameters, offering flexibility for any room lay-out and enabling value-adding scenographies.



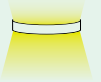

led

### SUPERNOVA SUSPENDED

Four discreet steel wires enable easy suspension of the Supernova range. The down-up version features a polycarbonate on top to avoid dust entering the fixture and guaranteeing a good indirect light effect. Thanks to the transparent supply cable and the new trimless suspension kit you can opt for a very clean and minimalistic ceiling suspension.

Ø 650 / 950 / 1250

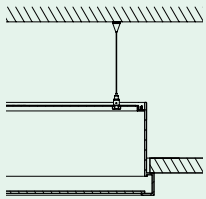

### SUPERNOVA SEMI

Because of a partly recessed installation, the Supernova semi appears like an ultra-flat luminous sphere on the ceiling. It's also quick to install, suspended from the slab with the trim covering the cut out.

Ø 672 / 972 / 1272

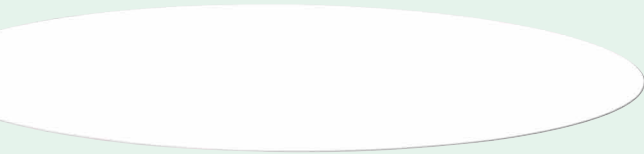

led

### SUPERNOVA TRIMLESS

The trimless recessed Supernova seamlessly integrates with the architecture of the room, giving emphasis on the light rather than the luminaire.

Ø 675 / 975 / 1275

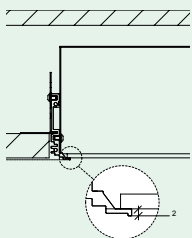

led

### SUPERNOVA SURFACE MOUNTED

A subtle lighting solution with powerful light output, blending well into any space. It's circular form and neutral character enhances any room.

Ø 650 / 950 / 1250



led

### SUPERNOVA RECESSED

The recessed and pivoted version is a particularly eye-catching option in the Supernova range. A recessed kit facilitates installation, prevents line of sight into the ceiling and allows you to customise depth and angle of the Supernova.

Ø 650 / 950 / 1250





# Supernova





# Logic

The Logic is for a new generation of floor recessed luminaires. A complete range of IP67 and shock-resistant (IK02, Max 25N/Cm<sup>2</sup>) LED in-ground luminaires with a powerful.

EXTERIOR



100%  
WATERPROOF



The choice of installation - recessed trimless or surface mounted trim - round or square shape allow you to match look & feel with the design of the building.

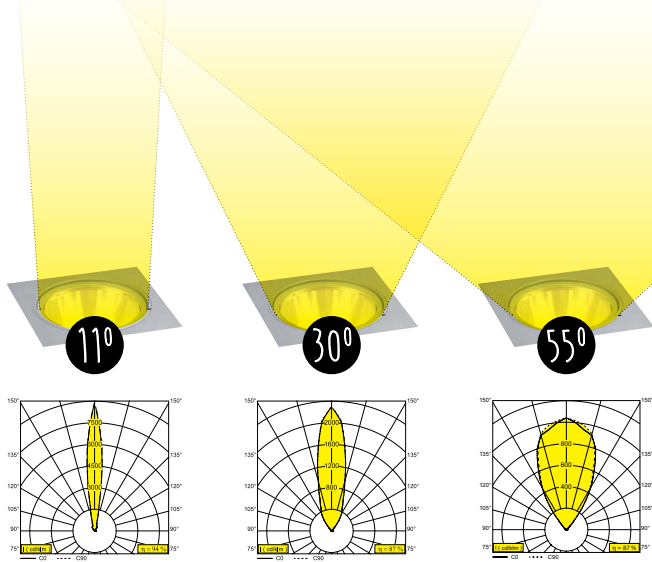

The uplight effect of the Logic serves to enhance the architectural character of your project and landscape. Thanks to its multiple **reflector options 11° / 30° / 55°** - Logic can be used to accentuate trees or sculptures, but also to uplight facades or large garden features, to create a sense of depth or indicate the right direction along paths and driveways.

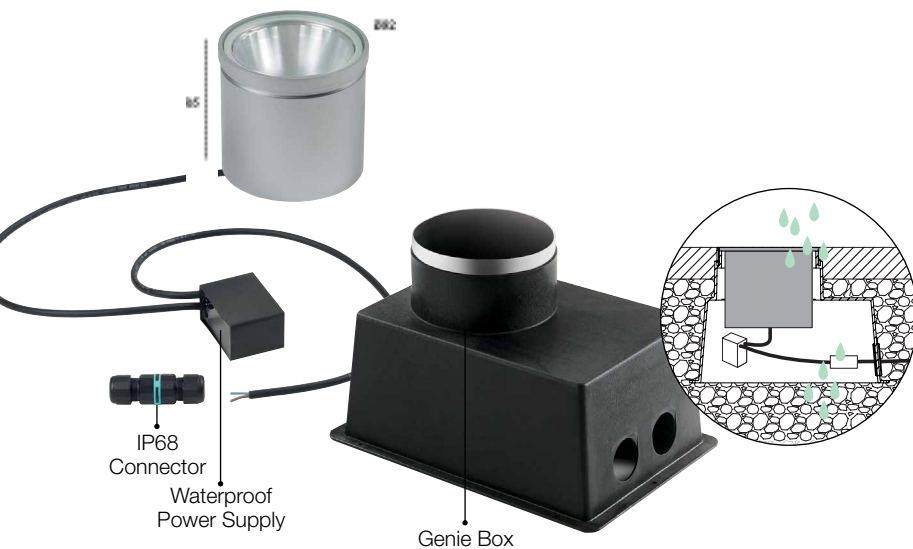
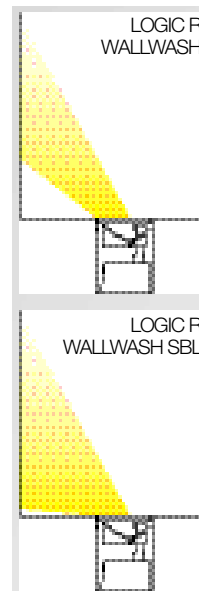

Installation is facilitated thanks to the incorporated **waterproof power supply** in the supply cable, and the **waterproof (IP68) connector** to connect directly to the mains. As the Logic fits in Delta Light®'s standard **Genie Box** you can now easily swop your Genie 90 dichroic ground spot with this new LED version.

Optimal cooling for extended LED lifetime due to housing in massive aluminium.

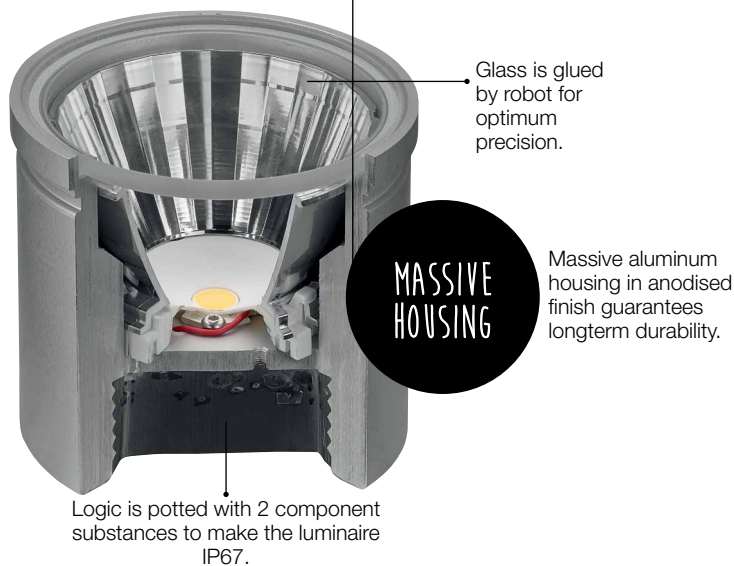

\* On request 4000K, 2700K, CR190





Logic

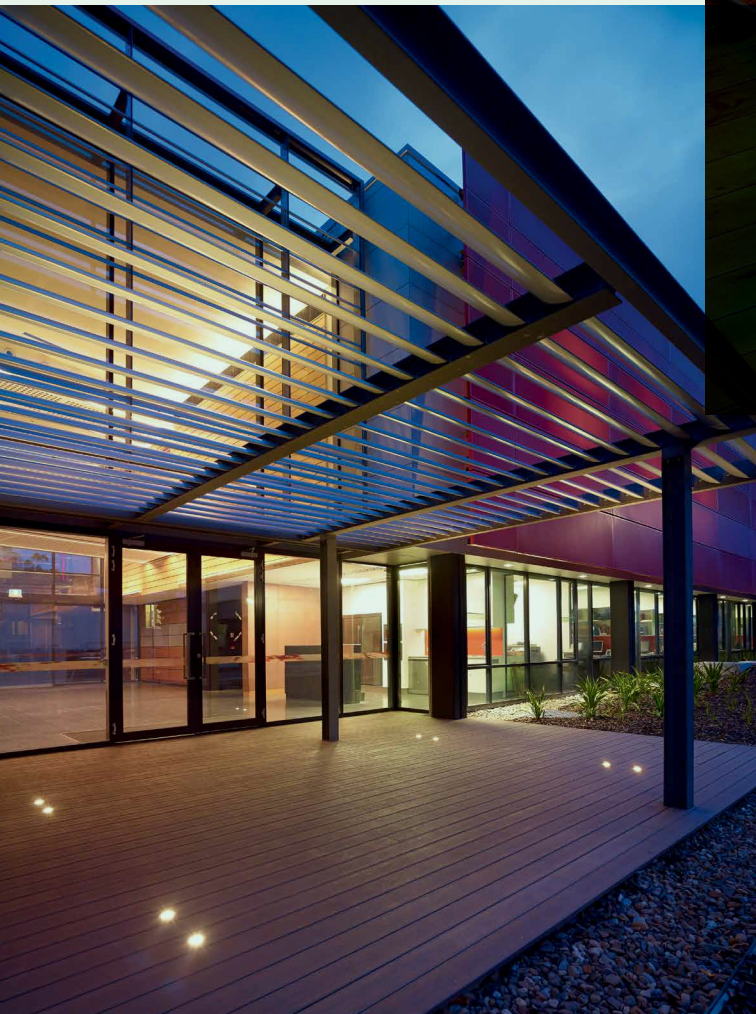

# 10 to look for in the Lighting Bible 10



1

The **Metronome XXL** is a truly unique creation, an immense eye-catcher able to upgrade any large space. With a height of 2.10m, the Metronome XXL can be seen as the pièce de resistance of the collection.



2

With **Tweeter Delta Light®** introduces the patented Excentric Rotation System. The ERS is characterized by a assymetrical hinge joint, combining extreme rotation and tilting abilities, all in one swift whirling motion.



3

**Splitline**  
Narrow and wide streets draw black lines through space and form a lighting path that dialogues with the architecture of the surroundings. This built-in profile can be interpreted in varied ways, depending on what the space needs, both functionally and in terms of design.



6

**Kix**  
A powerful and extremely versatile LED outdoor lighting solution. Available for wall or floor surface application.



7

**Reo**  
A new generation of dimmable recessed spots use carefully selected high performance leds that are the equivalent of 35-50 Watt halogen lamps, consuming no more than 7 Watt, and delivering a powerful, warm light. The Reo Led collection guarantees a perfect balance between lighting quality and energy efficiency.



4

The **Borderline** profile enables you to frame the room with light using led. This profile can be used for both wall and ceiling application, and features a remarkably trimless finishing.



5

The **Split-It** is a single profile which can be used on its own, or in combination of two. Different led, halogen or discharge modules tilt out from the profile, offering maximum flexibility.



8

Despite its remarkably slim dimensions, the **B-liner** wows you with its outstanding performance and efficiency. Thanks to the use of highly powerful led arrays, the B-liner scores a very high light output.



9

The **Bazil** outdoor luminaire consists of wall surface and different bollard versions. There are various post heights and thicknesses to choose from. The large models – which are also very robust – also fit in perfectly around office buildings, public buildings, hotels and grand houses.



10

Since its launch Vision has won various awards and received praise for its impressive defined beam on the wall. This classic is available for both interior and exterior use. Both come in different versions, either up light only or down or down/up.

# Service & Solution driven

Delta Light® has catered for some of the world's most well-known brands and architects, providing sophisticated and value adding lighting solutions. Ranging from retail to residential, office, public, showrooms to hospitality and landscape projects, small to very large scale, Delta Light® has the product range, experience and knowledge to meet the functional and aesthetic needs of your projects.

As each project requires a customized approach, Delta Light® is able to offer an exceptional package of services and design tools. The global team works with all stakeholders involved to get the best possible result; starting with lighting design services all the way down to the installation process and advise on environmental concerns. Be it for technical or application questions, performance and energy saving studies, a LEED assessment process, custom designs and made-to-measure solution, rendering or graphics needs, or any other lighting design related issue... Delta Light® provides a turnkey or one-stop-shop solution for your projects.



Residential



Office



Hotel



Retail



Hospitality



Public



Showroom



Retail

# Worldwide

Servicing Customers Worldwide

**Headquarters Delta Light® nv**  
Muizelstraat 2 / B-8560 Wevelgem (Moorsele) / Belgium  
Phone +32 (0)56 435 735 / Fax +32 (0)56 435 736  
E-mail: [info@deltalight.com](mailto:info@deltalight.com)  
[www.deltalight.com](http://www.deltalight.com)



ANTIGUA AND BARBUDA  
ARGENTINA  
ARMENIA  
ARUBA  
AUSTRALIA  
AZERBAIJAN  
BAHRAIN  
BELARUS  
BELGIE  
BOSNIA AND HERZEGOVINA  
BRAZIL  
BULGARIA  
CAMBODIA  
CANADA  
CHILE  
COLOMBIA  
CONGO  
COSTA RICA  
COTE D'IVOIRE  
CROATIA  
CYPRUS  
CZECH REPUBLIC  
DENMARK  
DEUTSCHLAND  
DOMINICAN REPUBLIC  
EGYPT  
EL SALVADOR  
ESTONIA  
ETHIOPIA  
FINLAND  
FRANCE  
GEORGIA  
GERMANY  
GREECE  
GUADELOUPE  
GUATEMALA  
HONG KONG  
HUNGARY  
ICELAND  
INDIA  
INGUSHETIA  
IRAN  
ISRAEL  
ITALY  
JAPAN  
JORDAN  
KAZAKHSTAN  
KENYA  
KOSOVO  
KUWAIT  
KYRGYSTAN  
LAOS  
LEBANON  
LIECHTENSTEIN  
LUXEMBOURG  
MACEDONIA  
MALAYSIA  
MALDIVES  
MALTA  
MAURITIUS  
MEXICO  
MOLDOVA  
MONTENEGRO  
MOROCCO  
NETHERLANDS  
NETHERLANDS ANTILLES  
NEW CALEDONIA  
NEW ZEALAND  
NIGERIA  
NORWAY  
OMAN  
PAKISTAN  
PALESTINA  
PANAMA  
PERU  
PHILIPPINES  
POLAND  
PORTUGAL  
PUERTO RICO  
QATAR  
ROMANIA  
RUSSIA  
SAINT VINCENT AND THE GRENADINES  
SAUDI ARABIA  
SERBIA  
SINGAPORE  
SLOVAKIA  
SLOVENIA  
SOUTH AFRICA  
SOUTH KOREA  
SPAIN  
SRI LANKA  
SURINAME  
SWEDEN  
SWITZERLAND  
SYRIA  
TAIWAN  
TAJKISTAN  
TANZANIA  
THAILAND  
TUNISIA  
TURKEY  
UKRAINE  
UNITED ARAB EMIRATES  
UNITED KINGDOM  
UNITED STATES  
URUGUAY  
VENEZUELA  
VIETNAM  
YEMEN

## Offices

**Asia**  
**Delta Light Asia Ltd.**  
Phone: +852 5501 7809  
E-mail: [asia@deltalight.com](mailto:asia@deltalight.com)  
[www.deltalight.com](http://www.deltalight.com)

**Belgium / Luxembourg**  
**Delta Light® nv**  
Phone: +32 (0)56 435 735  
Fax: +32 (0)56 435 736  
E-mail: [info@deltalight.be](mailto:info@deltalight.be)  
[www.deltalight.be](http://www.deltalight.be)

**Canada**  
**Delta Light Canada Inc.**  
Phone: +1 905 813 6130  
Fax: +1 905 813 7073  
E-mail: [canada@deltalight.com](mailto:canada@deltalight.com)  
[www.deltalight.ca](http://www.deltalight.ca)

**Czech Republic**  
**Delta Light Czech s.r.o.**  
Phone: +420 241 740 775  
+420 241 740 776  
Fax: +420 241 740 687  
E-mail: [info@deltalight.cz](mailto:info@deltalight.cz)  
[www.deltalight.cz](http://www.deltalight.cz)

**Denmark**  
**Delta Light Denmark Aps**  
Phone: +45 3311 4429  
E-mail: [info@deltalight.dk](mailto:info@deltalight.dk)  
[www.deltalight.dk](http://www.deltalight.dk)

**France**  
**Delta Light SAS**  
Phone: +33 (0)9 70 73 52 42  
Phone: +33 (0)9 70 73 52 43  
E-mail: [info@delta-light.fr](mailto:info@delta-light.fr)  
[www.delta-light.fr](http://www.delta-light.fr)

**Germany / Austria**  
**DELTA LINE + LIGHT GmbH**  
Phone: +49 (0)2451 4090-0  
Fax: +49 (0)2451 4090-200  
E-mail: [info@deltalight.de](mailto:info@deltalight.de)  
[www.deltalight.de](http://www.deltalight.de)

**Italy**  
**Delta Light Italia S.r.l.**  
Phone: +39 0 571 82226  
+39 0 571 93541  
Fax: +39 0 571 83594  
E-mail: [info@deltalight.it](mailto:info@deltalight.it)  
[www.deltalight.it](http://www.deltalight.it)

**Latin America**  
**Delta Light Latin America**  
Phone: +57 1 749 5307  
Mobile: +57 321 202 5501  
Mobile: +57 314 449 4015  
E-mail: [info@deltalight-latin.com](mailto:info@deltalight-latin.com)  
[www.deltalight-latin.com](http://www.deltalight-latin.com)

**Middle East & North Africa**  
**Delta Light Mena**  
Phone: +961 1 491 175  
Fax: +961 1 491 173  
E-mail: [sales@deltalight-mena.com](mailto:sales@deltalight-mena.com)  
[www.deltalight-mena.com](http://www.deltalight-mena.com)

**Poland**  
**Delta Light Poland**  
Phone: +48 698 33 00 03  
E-mail: [poland@deltalight.com](mailto:poland@deltalight.com)  
[www.deltalight.pl](http://www.deltalight.pl)

**Slovakia**  
**Delta Light Slovakia s.r.o.**  
Phone: +421 2 6353 0180  
Fax: +421 2 6353 0181  
E-mail: [info@deltalight.sk](mailto:info@deltalight.sk)  
[www.deltalight.sk](http://www.deltalight.sk)

**Russia, Eastern Europe, Middle Asia**  
**Delta Light REEMA**  
[reema@deltalight.com](mailto:reema@deltalight.com)  
Moscow:  
Phone: +7 926 03 888 93  
Saint-Petersburg:  
Phone: +7 921 79 183 88  
[www.deltalight.ru](http://www.deltalight.ru)

**Spain**  
**Iluminación Delta Light España S.A.**  
Phone: +34 (0)93 586 19 00  
Fax: +34 (0)93 697 95 00  
E-mail: [marketing@deltalight.es](mailto:marketing@deltalight.es)  
[www.deltalight.es](http://www.deltalight.es)

**Switzerland**  
**Delta Light AG**  
Phone: +41 (0)61 485 99 10  
Fax: +41 (0)61 485 99 11  
E-mail: [info@deltalight.ch](mailto:info@deltalight.ch)  
[www.deltalight.ch](http://www.deltalight.ch)

**The Netherlands**  
**Delta Light Nederland B.V.**  
Phone: +31 (0)88 80 40 600  
Fax: +31 (0)88 80 40 699  
E-mail: [info@deltalight.nl](mailto:info@deltalight.nl)  
[www.deltalight.nl](http://www.deltalight.nl)

**United Kingdom**  
**Delta Light UK LTD**  
Phone: +44 (0)870 757 7087  
Fax: +44 (0)207 620 0985  
E-mail: [info@deltalight.co.uk](mailto:info@deltalight.co.uk)  
[www.deltalight.co.uk](http://www.deltalight.co.uk)

**USA**  
**Delta Light USA, LLC.**  
Phone: +1 (954) 677 9800  
Fax: +1 (954) 677 1007  
E-mail: [info@deltalight.us](mailto:info@deltalight.us)  
[www.deltalight.us](http://www.deltalight.us)

Contact Details  
[www.deltalight.com/contacts](http://www.deltalight.com/contacts)



