

JOHN CULLEN

INSPIRE WITH LIGHT



JOHN CULLEN

BE INSPIRED ONLINE



Visit our website for the most up-to-date information on all of our products and services along with images for inspiration:

JOHNCULLENLIGHTING.CO.UK



Scan to see lighting brought to life

TEL. +44 (0) 207 371 9000

WELCOME TO A WORLD OF LIGHT



Lighting is a powerful and versatile tool that can bring your home to life. A good lighting scheme will enhance your interior and create real atmosphere. Once you know what it can do, the possibilities are endless; use it to add drama, or create a feeling of relaxation; to brighten a work space, or spotlight a precious object. It literally transforms a space.

More than any other tool, light is intangible and hard to get right, which is why I developed our London showroom to demonstrate the power of light.

John Cullen was founded in 1981, and now works on projects all over the world – from contemporary houses to period properties, hotels and even yachts. We're proud that our lights are designed in-house and that we support British manufacturing, and we passionately believe that energy efficiency should complement great design.

Whether you want to buy a single fitting or to commission an entire lighting scheme, our designers and sales team will help you find the best solution.

Many Thanks

A stylized, handwritten signature in black ink that reads "Sally". The signature is fluid and cursive, with a large loop at the beginning and a long, sweeping tail.

Sally Storey | **Design Director**

DESIGN SERVICE

At John Cullen we offer a bespoke design service to ensure that you have the right lighting for the right task. We'll help you with a scheme that will bring out the key features of your home or garden, and make each space come to life.

Lighting should never be an afterthought. It needs to be considered right from the start, with plans completed before the first electrical fix.

With help from our designers, we can create the right lighting solution that will show off everything from furniture to fabrics, artwork to architraves. We will talk you through the endless possibilities to create a tailor-made scheme that delivers the wow factor.

Our team of designers can either meet you on site, or you can visit our London design studio for a detailed discussion.

We work on an hourly basis or we can prepare a proposal for visits around the UK and abroad.



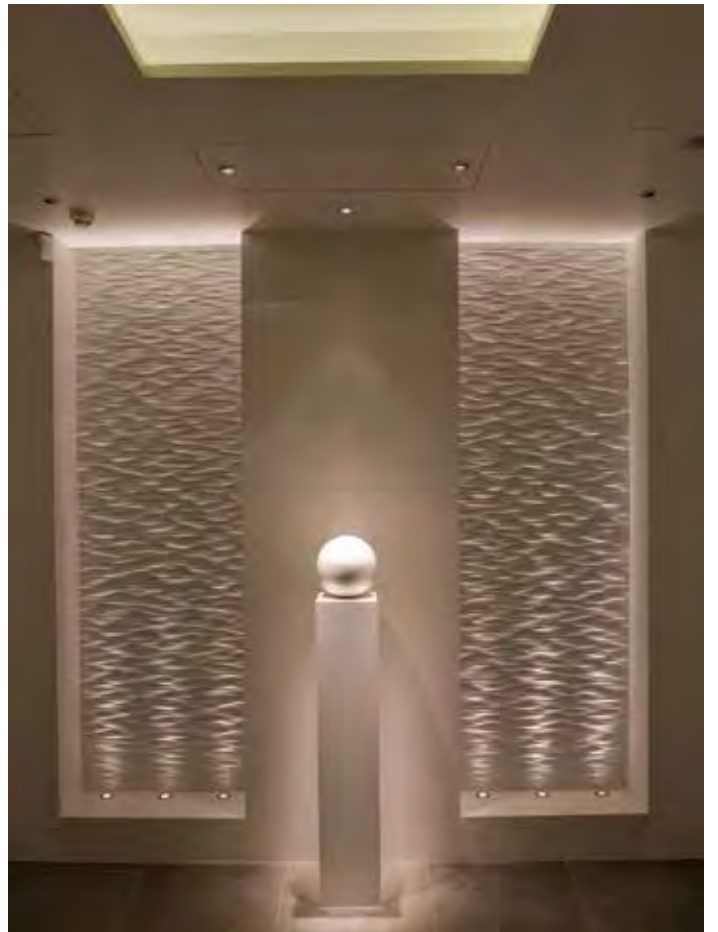
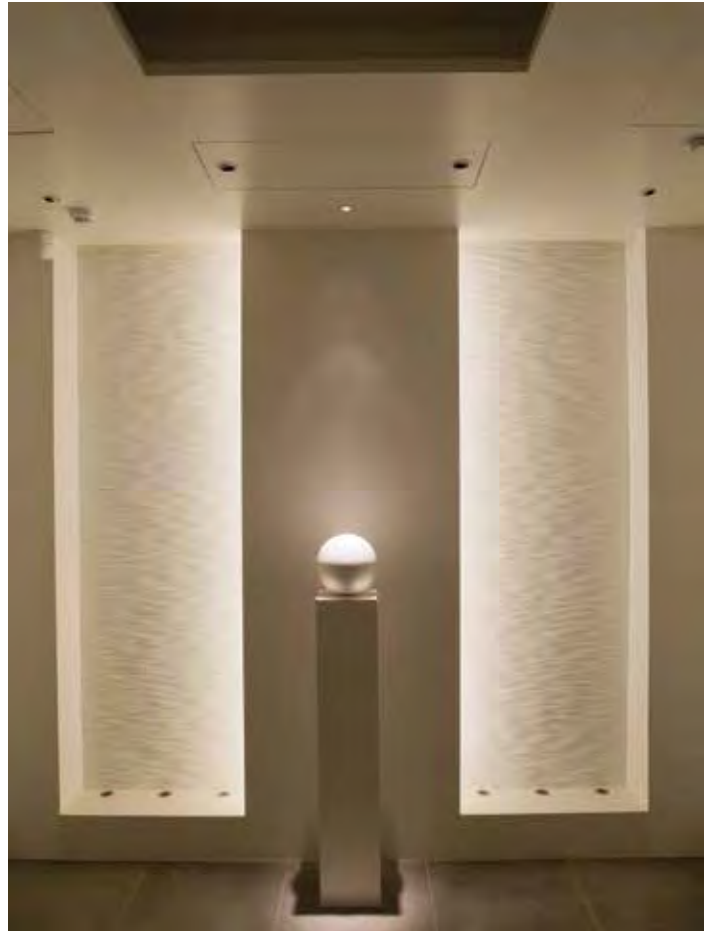

SHOWROOM DEMONSTRATIONS, MASTERCLASSES & CPDS

We offer demonstrations and masterclasses to help and inspire you. Visit our state-of-the-art showroom to be amazed by the latest in energy-efficient solutions and discover how much your home can benefit from a creative lighting scheme.

Stunning effects are displayed in specially designed sets for the kitchen, dining room, bedroom, bathroom and sitting room, depending on which room you are looking to light.

Our full black-out facilities enable you to see the power of light and how it can transform a space at the touch of a button, whether it's for an object, a room or the whole house and garden.

Our masterclasses, run by design director Sally Storey, are ideal for anyone wanting inspiration or needing advice, and we also offer a range of BIID and RIBA accredited CPDs for interior designers and architects, as well as specific classes in exterior lighting.

Check the website for dates of masterclasses and CPDs, although we can arrange the latter to suit. Or just drop into the showroom where our experts are on hand to help you.

INSPIRATION FOR HALLS & STAIRS



Halls and staircases can be narrow and dull, yet they create the first impression and set the tone for a house. Create impact by over-scaling a decorative pendant and dimming this for mood and add layered lighting effects to add drama to the space. Staircases can be interesting architectural features and a well-lit staircase can be regarded as a sculpture within the house.

INSPIRATION

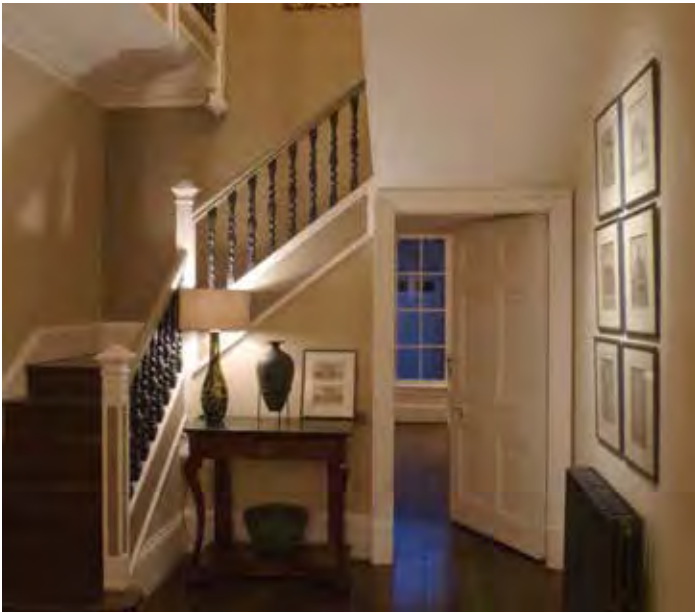
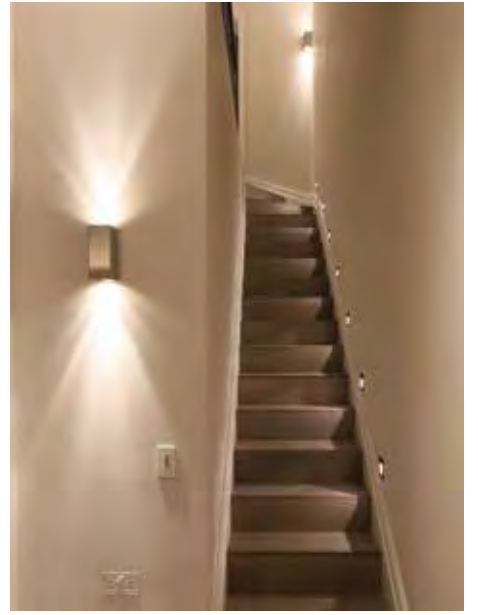
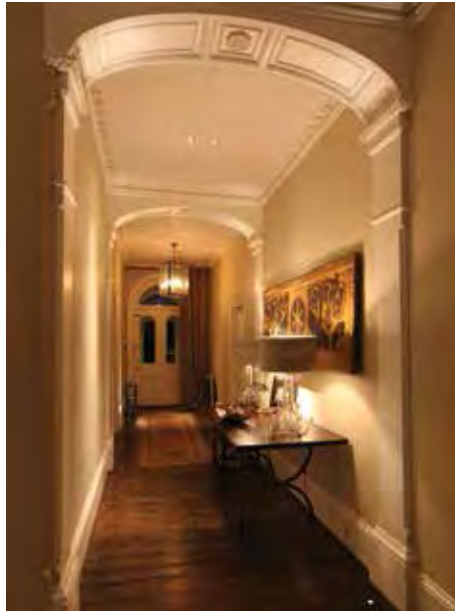



INSPIRATION FOR RECEPTION ROOMS



Before you make decisions on lighting, work out exactly where your furniture will be positioned and what focal points you want to highlight. Paintings, furniture, sculpture or other works of art can each be accentuated. Consider integrating lighting into your shelving to highlight books or objects and think about lighting the table at the centre of a room as this pulls the seating together.

INSPIRATION FOR KITCHENS



The kitchen is the heart of the home. Often it is not just a kitchen but works as a multi-functional dining, living and working area. The best way to maximise these different uses throughout the day is with clever lighting and flexible control. This ensures a cohesive space that the whole family can use and enjoy.

INSPIRATION

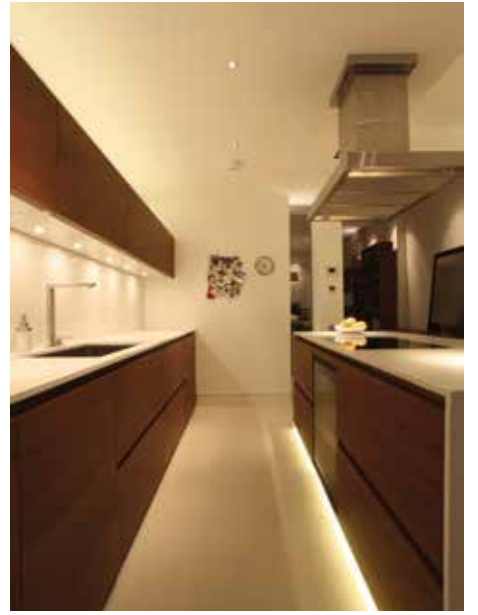
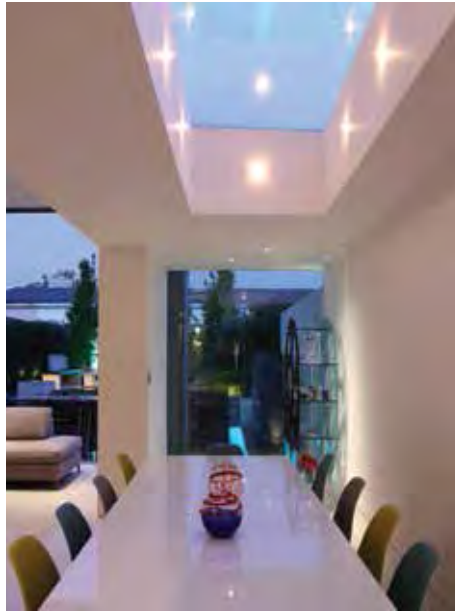
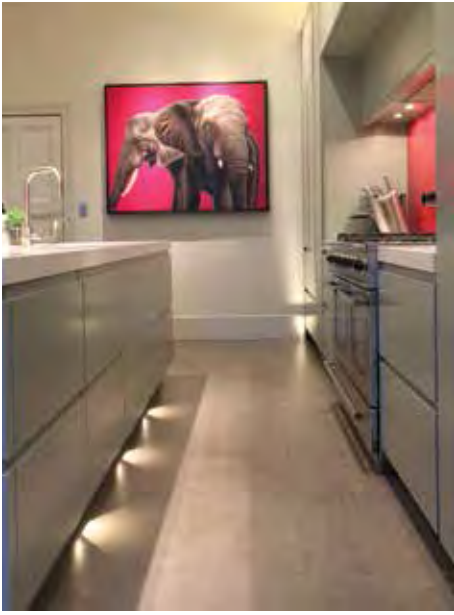



INSPIRATION FOR BEDROOMS & BATHROOMS



Good lighting can transform your bedroom and bathroom from a practical early morning room to an atmospheric spa to relax in at night. Enhance the material you choose with creative lighting and make even simple white tiles appear glamorous. Lighting can make a small room seem bigger or a large room feel more intimate. Layer lighting with a combination of functional shadow-free lighting around the mirror, directional downlights to highlight textures and uplights for drama and mood.

INSPIRATION FOR ENTERTAINMENT ROOMS



Be adventurous with lighting your entertainment rooms to increase your enjoyment of them. From creating a twinkly lighting effect at the bottom of a pool, incorporating a colour-changing coffer or wall wash to ensuring different moods in a gym to help you work out more effectively, use lighting to enrich both the space and your mood.

INSPIRATION

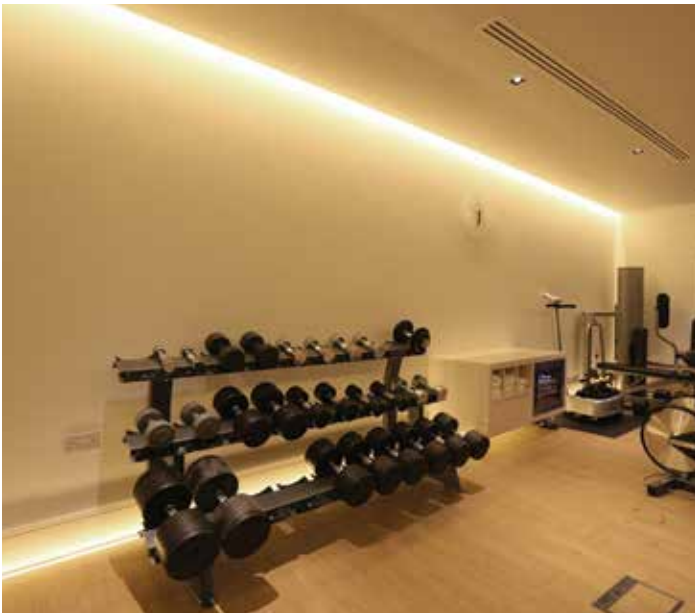



INSPIRATION FOR GARDENS



A little light goes a long way at night; it is important to decide which features to light and how intensely. Use lighting selectively, making use of both the darkness and light to enhance the best elements of your garden. The key to successful garden lighting is flexibility and using spiked fittings ensures they can be repositioned for best effect as your garden grows and the seasons change.

AN OVERVIEW OF OUR PRODUCTS



Designed in-house
Supporting British Manufacturing

To help you achieve the potential from your beautiful home, we have developed an entire range of products to create the most successful lighting scheme. We pay close attention to detail to ensure the optimum result, and use state-of-the-art technology throughout.

All our LED lights are the highest quality warm white, 2700K, and individually batched together for colour consistency, essential where you have a run of fittings. We ensure that each fitting has the maximum Lumens (light output) possible using the least amount of power (wattage) to ensure maximum efficiency, and a variety of beam widths and accessories gives you versatility with the effects that can be achieved.

All our products also have high CRI (colour rendering index) of over 90 so that you see the colours in your home as they were meant to be seen, and not altered by the light as can happen with inferior LEDs.

But that's not all: our fittings are discreetly sized so that you see the effect they give, rather than the products themselves.

Our in-house product designers are constantly monitoring new developments in technology to ensure that we offer the very best and most up-to-date products available, and everything is precision engineered to 0.01mm tolerance.

Manufacturing in the UK supports British industry and allows us to keep a close eye on quality control. We build great relationships with our manufacturers, which means we can ensure that our products are made to the highest standards, with close attention paid to every detail. Every single light is hand finished and quality checked to make sure it's perfect.

We have all the tools you need to create the space you desire. Be inspired by light!

PRODUCT OVERVIEW

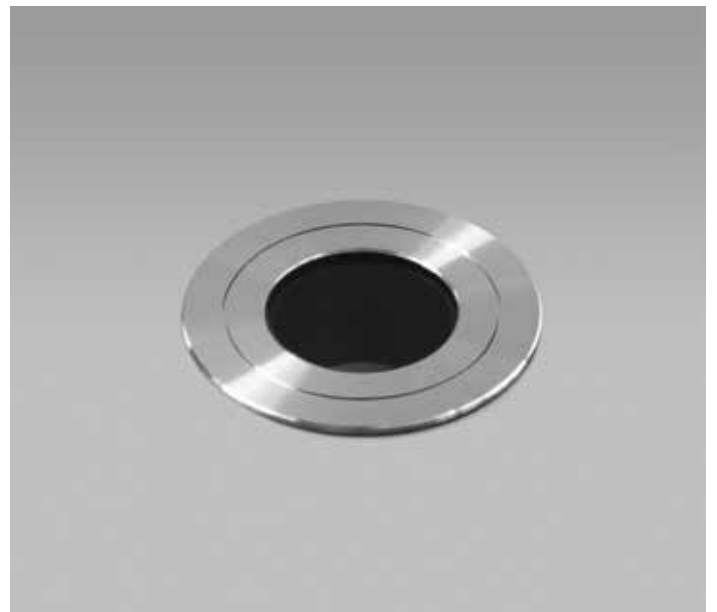
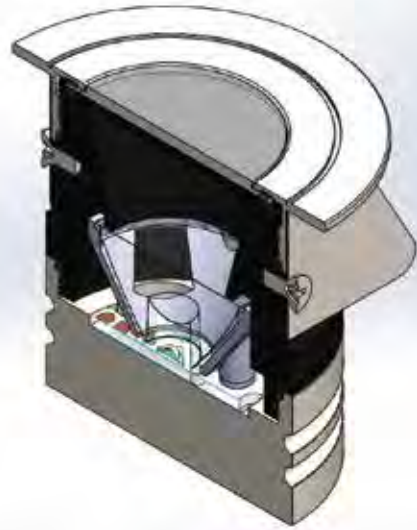
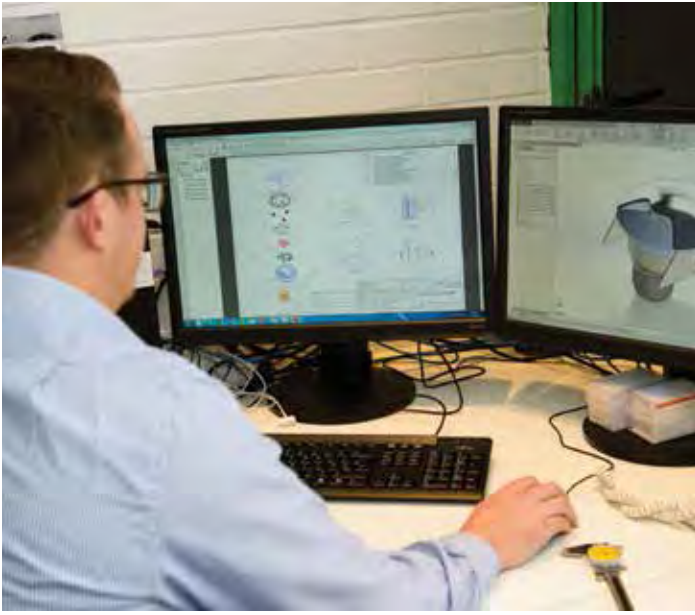

RECESSED PRODUCTS

All our LED downlights have been designed to give you the best quality of light for your home using the latest energy efficient LEDs. They offer a warm white light of 2700K and a high CRI of 95 to ensure that the true colours of your interiors are shown. With deep baffles to reduce glare, a range of beam widths for flexibility and a number of finishes, our downlights deliver the perfect solution.

For full specification details, visit our website.



POLESPRING

Directional downlight with minimal bezel for discreet installation*

B667901 White



*Available with 10°, 26° or 36° beam.

RECESSED PRODUCTS



FLUSH

Directional downlight for use when a minimal look is required.*

B627901 White



MIRA

Shallow version of the Polespring for increased light output*

A407901 White



POLESPRING 360

Directional downlight with additional 360 rotation for flexibility*

B677901 White



SQUARE TRIM AND TRIMLESS

Architectural directional downlight*

K807902 Trim black with black insert
K817901 Trim white with white insert
K827902 Trimless black
K837901 Trimless white
Other combinations available



SQUARE DOUBLE TRIM AND TRIMLESS

Twin version of this architectural directional downlight*

K847902 Trim black with black insert
K857901 Trim white with white insert
K867902 Trimless black
K877901 Trimless white
Other combinations available



FAZER

Mini directional downlight for reduced ceiling heights, niches and joinery.

B717501 White 10°
B717506 Bronze 10°
B717510 Aluminium 10°
Also available with 36° beam



WATERSPRING

Waterproof downlight with deep baffle for ultra low glare and minimal bezel IP54*

A377901 White



AQUABEAM

Directional waterproof downlight with deep baffle for ultra low glare and minimal bezel IP54*

B217901 White



MINI STARLIGHT

Semi recessed star effect light perfect in conjunction with glass and mirror.

A151301 White
A151307 Bright chrome
A151308 Satin chrome

SURFACE MOUNTED

Our range of surface mounted spotlights are ideal when you are unable to recess fittings such as concrete or sloped ceilings and beamed areas. You can expect the same quality of light as our recessed fittings, with warm white 2700K colour and a high CRI of 95 to ensure that the true colours of your home are shown. For full specification details, visit our website.



MINOS

Surface mounted directional spotlight with deep baffle for low glare

- C141001 White
- C141002 Black
- C141006 Bronze
- C141010 Aluminium



EDEN

Surface mounted floodlight for wall wash effect

- C227901 White
- C227906 Bronze
- C227910 Aluminium



SHELF LIGHTS

Here is a range of solutions for use in shelves and bespoke cabinetry to suit your interiors. All offer a warm white light of 2700K using the latest energy efficient LEDs. For full specification details, visit our website.



UNDERCUPBOARD LIGHT

Recessed task and display light

- L517501 White
- L517506 Bronze
- L517510 Aluminium



EYELID UNDER CUPBOARD LIGHT

Low glare recessed task and display light

- L527501 White
- L527506 Bronze
- L527510 Aluminium



LUCCINI

Miniature downlight for use in niches and joinery to create a jewel like effect

- E847517 Stainless steel



FOOTLIGHT

Miniature surface mounted display light

- L267506 Bronze
- L267510 Aluminium

LINEAR SOLUTIONS

Our linear strips have been designed in a range of different colour temperatures as it is important to select the best solution to suit what you are lighting. Using the latest LED technology, they have an extremely slim profile so can easily be concealed and come with a range of accessories to suit varying installations. For full specification details, visit our website.

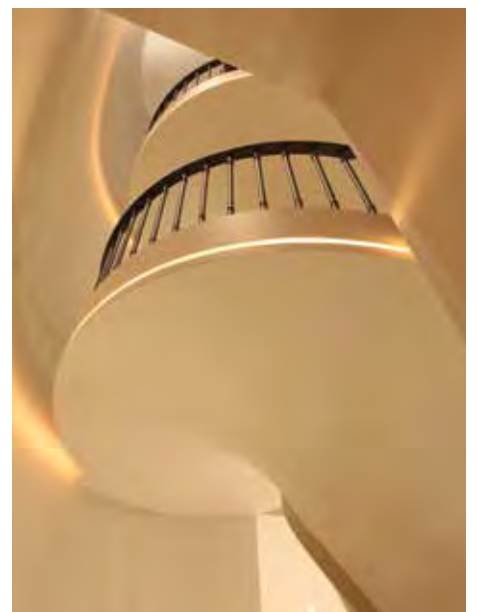

LINEAR SOLUTIONS



CONTOUR ^{HD24}

Ultra warm white strip

L282400 2400K



CONTOUR ^{HD27}

Warm white strip to match our range of fittings

L282700 2700K



CONTOUR ^{SE27}

A side emitting version useful in curved installations

L187400 2700K



CONTOUR ^{RGB}

Colour changing strip

L136900 RGB



EXTRUSIONS

Wide range of extrusions for bespoke integration to maximise the desired effect



CONTOUR ^{HDX}

For use in wet areas such as bathrooms or gardens IP65

P582400 HDX24

P582700 HDX27



STEP AND UPLIGHTS

This collection of products is ideal for illuminating steps, walls, columns, arches, bookcases, fireplaces and window reveals. All offer a warm 2700K light source to match our range and come in various shapes, sizes and finishes to suit your interior. For full specification details, visit our website.



LUCCA

Versatile low glare up, down and step light

E807506 Bronze

E807509 Nickel

E807517 Stainless Steel

E807528 Primed

Available as an 8° as standard or a 30° with an optic accessory.



RIVA

Floor and step light with an angled beam of light

E797406 Bronze

E797409 Nickel

E797417 Stainless Steel

E797428 Primed



SIENA

Cowled floor and step light for ultra low glare

E837506 Bronze

E837509 Nickel

E837517 Stainless Steel

E837528 Primed

Available as an 8° as standard or a 30° with an optic accessory.



LUCCINI

Miniature downlight for use in niches and joinery to create a jewel like effect

E847517 Stainless steel



TORINO

Step and uplight for where more light output is required IP67

R905917 Stainless steel



MANHATTAN

Architectural floor and step light with an angled light

E817406 Bronze

E817407 Polished stainless steel

E817416 Brushed stainless steel

E817428 Primed

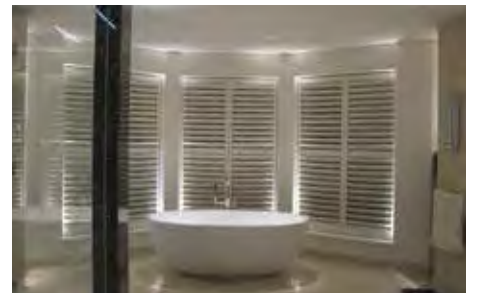
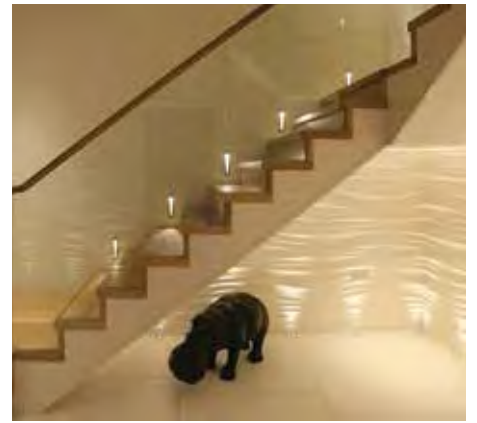

OSLO

Glass fronted floor and step light

- E787401 White
- E787406 Bronze
- E787407 Bright chrome
- E787416 Stainless steel
- E787428 Primed

CAZALLA

Miniature floor and step light

- E827401 White
- E827406 Bronze
- E827407 Bright chrome
- E827416 Stainless Steel
- E827428 Primed

BUTTON

Low profile indicator light with varying facets IP67

- R417417 Stainless steel 1 facet
- R427417 Stainless steel 2 facets north/east
- R437417 Stainless steel 2 facets north/south
- R447417 Stainless steel 4 facets

WALL LIGHTS

Wall lights provide an excellent way of adding an additional layer of light to a space. We offer a wide variety of solutions to suit your requirements. For full specification details, visit our website.

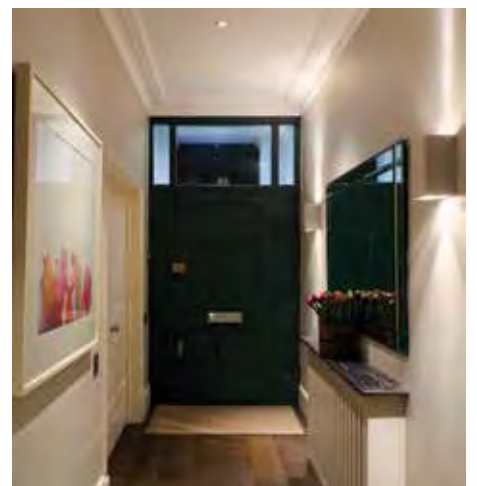

WALL LIGHTS

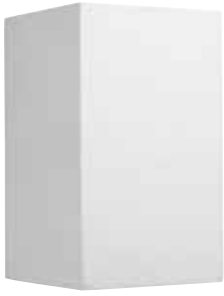

PLASTER SQUARE

Contemporary paintable pillar style up/downlight

G135830 LED

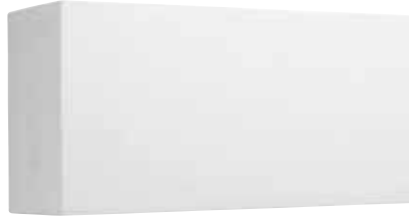

PLASTER RECTANGLE

Contemporary paintable up/downlight

G115730 LED



PLASTER RECTANGLE SLIM

Contemporary paintable slim uplight

G105730 LED



PLASTER CUBE

Contemporary paintable up or down light

G185830 LED



PLASTER FLAT

Super slim contemporary paintable up/downlight

G205730 LED



PLASTER FLAT GRANDE

High output slim contemporary paintable up/downlight

G215730 LED



SHANGHAI

Contemporary up/downlight with silk shade

Y295102 Shanghai 2 x 26w gear tray

Y295302 Small Shanghai 13w gear tray

Finishes available: Porcelain, Pebble, Flame, Birch, Lime, Aster, Violet and Jade. See website or call for codes.



METAL SQUARE

Contemporary 12v up/downlight

G161001 White

G161006 Bronze

G161012 Gunmetal

G161016 Stainless steel



SKINNY

Cylindrical 12v up/downlight

G241007 Chrome

LIGHTING ARTWORK

With all our solutions for lighting artwork, you can be assured of the highest 95 CRI to ensure the true colours of your artwork are seen along with a warm white light to match our full range. For full specification details, visit our website.



CONTEMPORARY PICTURE LIGHT

Slim contemporary LED picture light

Available in a wide range of finishes and sizes.
Fittings are made to order.



TRADITIONAL PICTURE LIGHT

Slim traditional LED picture light

Available in a wide range of finishes and sizes.
Fittings are made to order.



POLESRING

Directional downlight with minimal bezel for discreet installation

B667901 White
Available with 10°, 26° or 36° beam with a range of accessories to alter the beam to suit the artwork



FRAMING PROJECTOR

Fully concealed projector light for uniquely subtle silhouette effect for artwork and sculpture

M801400 London
M831400 UK (excl London)
M811400 Commercial
M821400 Rest of World



TASK LIGHTS

These useful fittings will ensure that you can add extra task light where it is needed, without the need for additional wiring (Cama excluded). The Pocket of Light and Cama both use warm white LEDs to match the rest of the John Cullen range. For full specification details, visit our website.



SQUARE HIGHLIGHT

Small portable 12v directional uplight

G341001 White
G341006 Bronze
G341012 Gun metal



POCKET OF LIGHT

Floor standing portable task light with memory dimming

G397806 Bronze
G397809 Nickel
G397829 Satin nickel



CAMA

Flexible low heat bedside reading light

G367506 Bronze
G367507 Bright chrome
G367529 Satin nickel



BATHROOM LIGHTS

These fittings will ensure that you have excellent shadow-free light where you need it most. A selection of different designs enable you to create the perfect look for your bathroom. For full specification details, visit our website.



BATHROOM LIGHT

Elegant surface mounted bathroom mirror light

J105207 Bright chrome IP54



WILTON

Elongated Art Deco style surface mounted bathroom mirror light

J126007 Bright chrome IP54



GRISSINI

Handmade bathroom mirror pendant

J161917 Stainless steel IP44
Made to order



PENNE

Handmade ribbed bathroom mirror pendant

J181917 Stainless steel IP44
Made to order



BARI

Compact bathroom mirror light

J131907 Bright chrome IP44



KYOTO

High output bathroom mirror light

J145407 Bright chrome IP44

BATHROOM LIGHTS

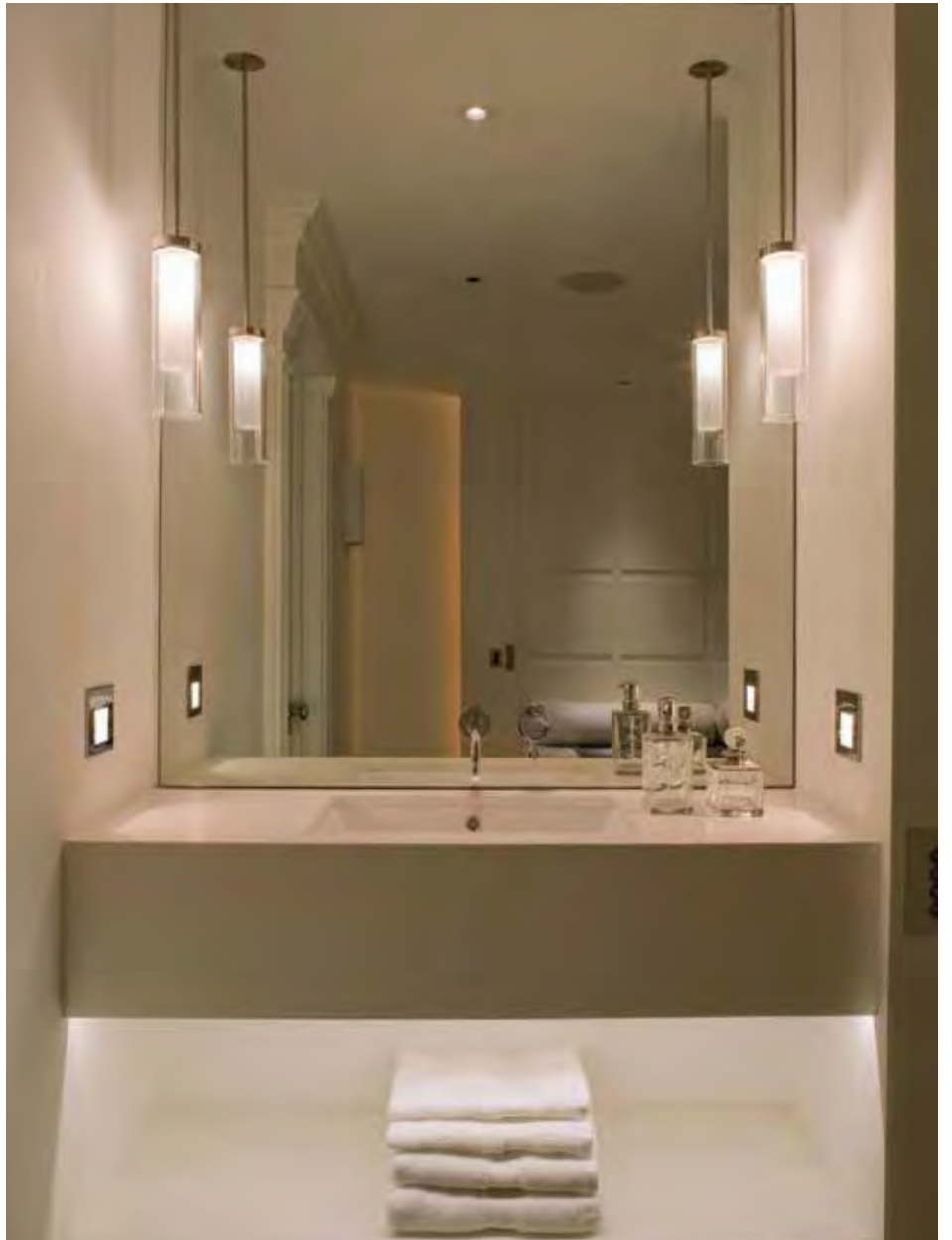

GARDEN LIGHTS

Lighting the garden creates a magical place at night. Our wide range of fittings allows you to select the best products to enhance the features in your garden. For full specification details, visit our website.

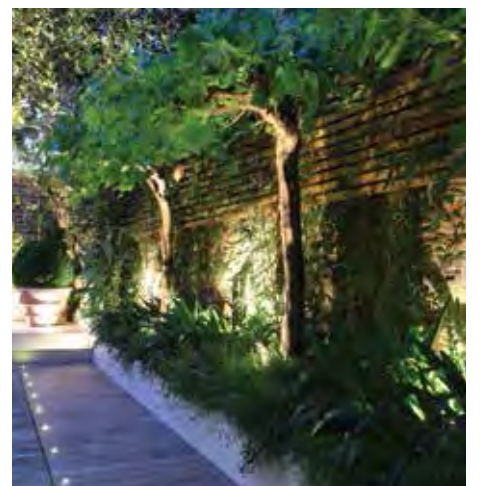

GARDEN LIGHTS



KEW

Miniature directional spotlight with ground spike IP67

R207525 Olive green

Available as a 30° as standard or an 8° with an optic accessory.



HAMPTON

Miniature directional floodlight with ground spike IP67

R217525 Olive green



KENSINGTON

High-output directional spotlight with ground spike IP67

R197925 Olive green

Available as a 10° as standard or an 36° with an optic accessory.



RICHMOND

High-output directional floodlight with ground spike IP67

R187925 Olive green



ESSEX

Decorative 230v wall lantern IP44

Available in weathered brass, chrome, dull nickel, dull chrome and polished nickel either with clear or frosted glass or gauze or mesh. Please ask for details.



ANNET

Decorative 230v slim wall lantern IP44

Available in weathered brass, chrome, dull nickel, dull chrome and polished nickel either with clear or frosted glass or gauze or mesh. Please ask for details.



WALL SPOTLIGHT

Adjustable spotlight IP66

P141001 White

P141002 Black

P141003 Copper

P141017 Stainless steel

Fixed downlight, 230v and integral versions available.



PILLAR LIGHT

Architectural 12v up/downlight IP66

P281001 White

P281002 Black

P281003 Copper

P281017 Stainless steel

230v and integral versions available



MESH WALL

Architectural 12v up/downlight with mesh top IP66

P301003 Copper

P301017 Stainless steel

Integral version available

GARDEN LIGHTS

Our collection of IP rated step and uplights will add low level drama to your exterior or bathrooms. The versatile range produce a warm white light to match with our interior fittings. For full specification details, visit our website.



GARDEN LIGHTS



LUCCA EXTERNAL

Versatile low glare up, down and step light for wet areas IP67

R807506 Bronze

R807517 Stainless steel

Available as an 8° as standard or a 30° with an optic accessory.



SIENNA EXTERNAL

Cowled floor and step light for ultra low glare for wet areas IP67

R837506 Bronze

R837517 Stainless steel

Available as an 8° as standard or a 30° with an optic accessory



TORINO

Step and uplight for where more light output is required IP67

R905917 Stainless steel



BUTTON

Indicator light with varying facets IP67

R417417 Stainless steel 1 facet

R427417 Stainless steel 2 facets north/east

R437417 Stainless steel 2 facets north/south

R447417 Stainless steel 4 facets



ILFORD FLOOR

Decorative pathway lantern IP44

Available in weathered brass and a large version.

Mains or battery operated. Please ask for details.



CONTOUR HDX

For use in wet areas such as bathrooms or gardens IP65

P582400 HDX24

P582700 HDX27



STARLITER

Pendant with 360° twinkling effect IP65

P607503 180mm copper

P617503 260mm copper

P627503 330mm copper



MOONLIGHTER

Tree mounted 230v downlight creating a moonlight effect IP54

P373106 Bronze



SPINAKER

Marine style 12v downlight IP54

P331006 Weathered bronze

P331007 Polished aluminium

P331010 Aluminium

P331021 Polished bronze

CONTROLS & DIMMERS

To maximise the effects achievable with lighting, good controls are essential. We offer a range of options across different price points to suit your needs. Please call to discuss.



ROTARY DIMMER

The simplest way to change the mood.



DOLLY/ROCKER SWITCH

Basic on/off switch for secondary areas.



MOMENTARY DIMMER

For use where multiple dimming points are needed.



SOCKETS AND DATA

A complete range of sockets and data points to match our range of switches.



TABLET AND USER INTERFACE

Wired and wireless systems incorporating tablet user interface for complete flexibility and control.



SCENE SETTING CONTROL

Easy to use single room scene setting combining circuits to create specific moods which can be recalled at the touch of a button.



OUTSTANDING SERVICE

Our friendly and knowledgeable sales team are at hand to ensure a smooth process from purchase to delivery. They will advise you accordingly – ensuring that all the correct lamps or bulbs, transformers, drivers and accessories are specified with each product. Your contractor can call up at any time for technical advice to aid correct installation of our fittings.



All products will be collated on a circuit by circuit, room by room basis for ease of installation on site, saving time and making life as easy as possible for your electrician.

We carry large stocks of our most popular products for immediate delivery from our Distribution Centre. Bespoke items often take longer but we are happy to send the rest of your order in advance.

We have a collection counter at our Customer Service Centre. If you wish to collect your items, calling us in advance will allow us to have your order ready and avoid you waiting during busy times.

Copyright © John Cullen 2015. John Cullen reserve the right to change the design and specification of our product range without prior notice. Our published terms and conditions apply E&OE.

“In contemplating a refurbishment of our home, we knew that that lighting was fundamental...I now realise that there is scarcely a colour scheme, nor finish, nor furniture piece, nor design that is not brought to life by the right lighting...For that single reason, it was John Cullen, after a 12 month refurbishment, that created the home we hoped for.”

Matthew Fosh, London

“You seem to have gone overboard to help us, and have so understood my style. Lighting is so complicated for us mere mortals!”

Claire Allen, Wiltshire

“The showroom is incredibly useful to visit because it is difficult to visualise the effect of lighting! However over and above that you were very courteous, polite, attentive and insightful. We will be sure to recommend you to others.”

Mr and Mrs Panikker, London

SHOWROOM AND DESIGN

Email: design@johncullenlighting.co.uk

561-563 Kings Road
London
SW6 2EB

Tel: +44 (0) 20 7371 9000

Opening Hours

9.30 to 5.30pm Monday to Friday

10.00am to 4.00pm Saturday

(Excluding Bank Holidays)

CUSTOMER SERVICE AND DISTRIBUTION CENTRE

Email: sales@johncullenlighting.co.uk

Unit 24
Talina Centre
Bagley's Lane
London
SW6 2BW

Tel: +44 (0) 20 7371 9000

Opening Hours

8.00 to 6.00pm Monday to Friday

JOHNCULLENLIGHTING.CO.UK