





# WELCOME TO OUR WORLD



**We make light that makes you see, light that makes you look, light that animates the world around you.**

We develop lighting solutions that enhance people's life, and therefore people's quality of life. We bring our experience in light to the service of architects, interior and lighting designers, realizing what is in their mind, creating a lighting scenography integrated in the architecture. Using the right light in the right way to make architectural concepts stand out.

Founded by designer **Paul Ameloot**, today the company is still owned and managed by the family. As **a family business** we love to share our passion, creativity and dedication.

Our aim is to inspire people all around the world.

As a family we have a personal stake in making your project successful.

We strive to be the best in all we do.

Building on 25 years of lighting development, production and design expertise, we look very ambitious but confident towards **the future**. We continuously invest in people, in new markets, in production techniques and in our infrastructure – aiming to further upgrade our service abilities, expand our R&D department, testing and laboratory facilities, increase warehouse automation and extend the House of Light training center.



At Delta Light we realize that our business activities are associated with responsibility for ecological awareness, health and sustainability, and handle these issues as a priority. Over the past few years Delta Light has been working to minimize the environmental impacts of its products and manufacturing processes, aiming to further increase the energy efficiency of the company.



# PINTOR <sup>led</sup> TRIMLESS / ST

PAG 10-17

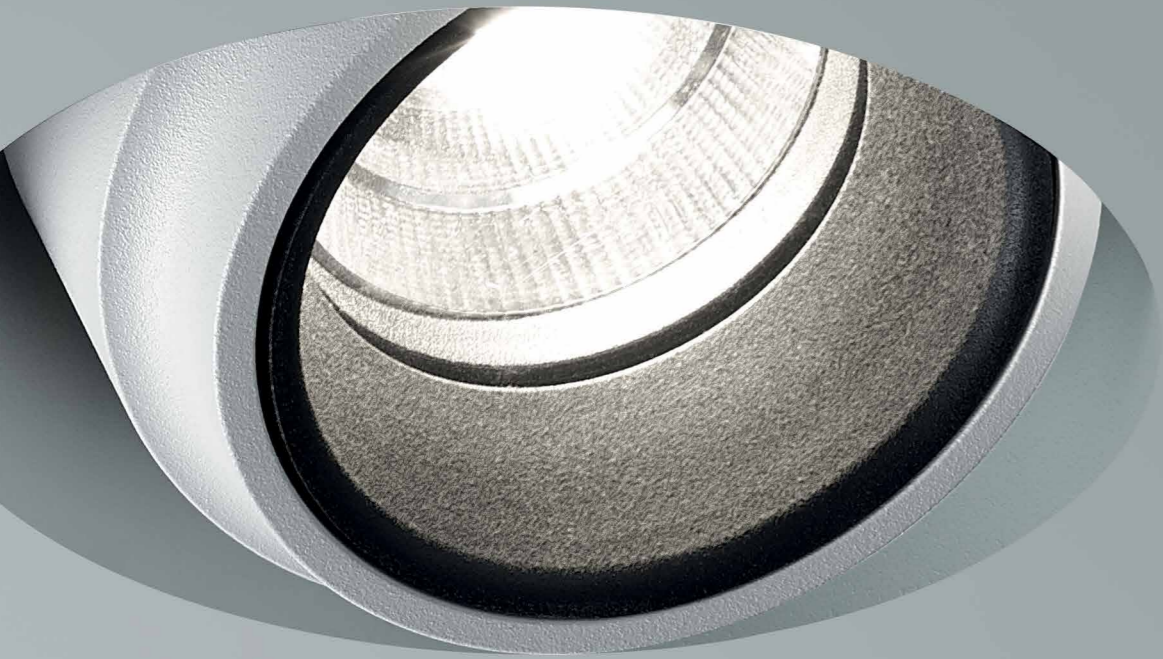

PINTOR 63 TRIMLESS



PINTOR 63 ST



PINTOR 90 TRIMLESS



PINTOR 90 ST



PINTOR 90 ST

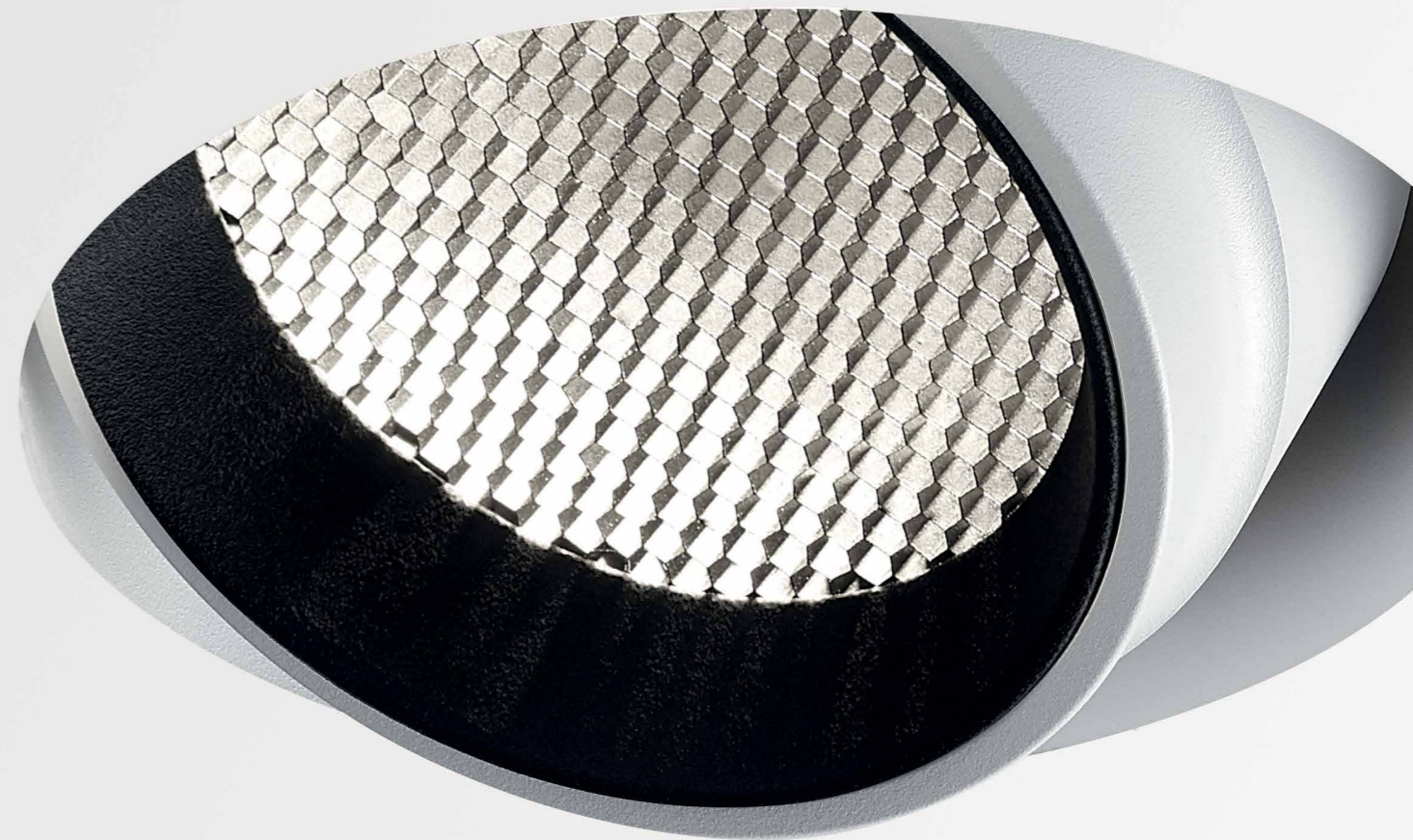

PINTOR 90 TRIMLESS



**GYN** led  
/ OK

PAG 18-20





# DIRO TRIMLESS OK LED led

## MICRO REO led

# GRAND REO TRIMLESS led

PAG 22-23



DIRO TRIMLESS OK LED



GRAND REO TRIMLESS



MICRO REO





# RINGO LED / IP CIRCLE LED

PAG 24-25



RINGO LED



RINGO LED IP



CIRCLE LED







# DEEP RINGO <sup>led</sup>

## LED IP / HI

PAG 26-27



DEEP RINGO LED IP



DEEP RINGO HI

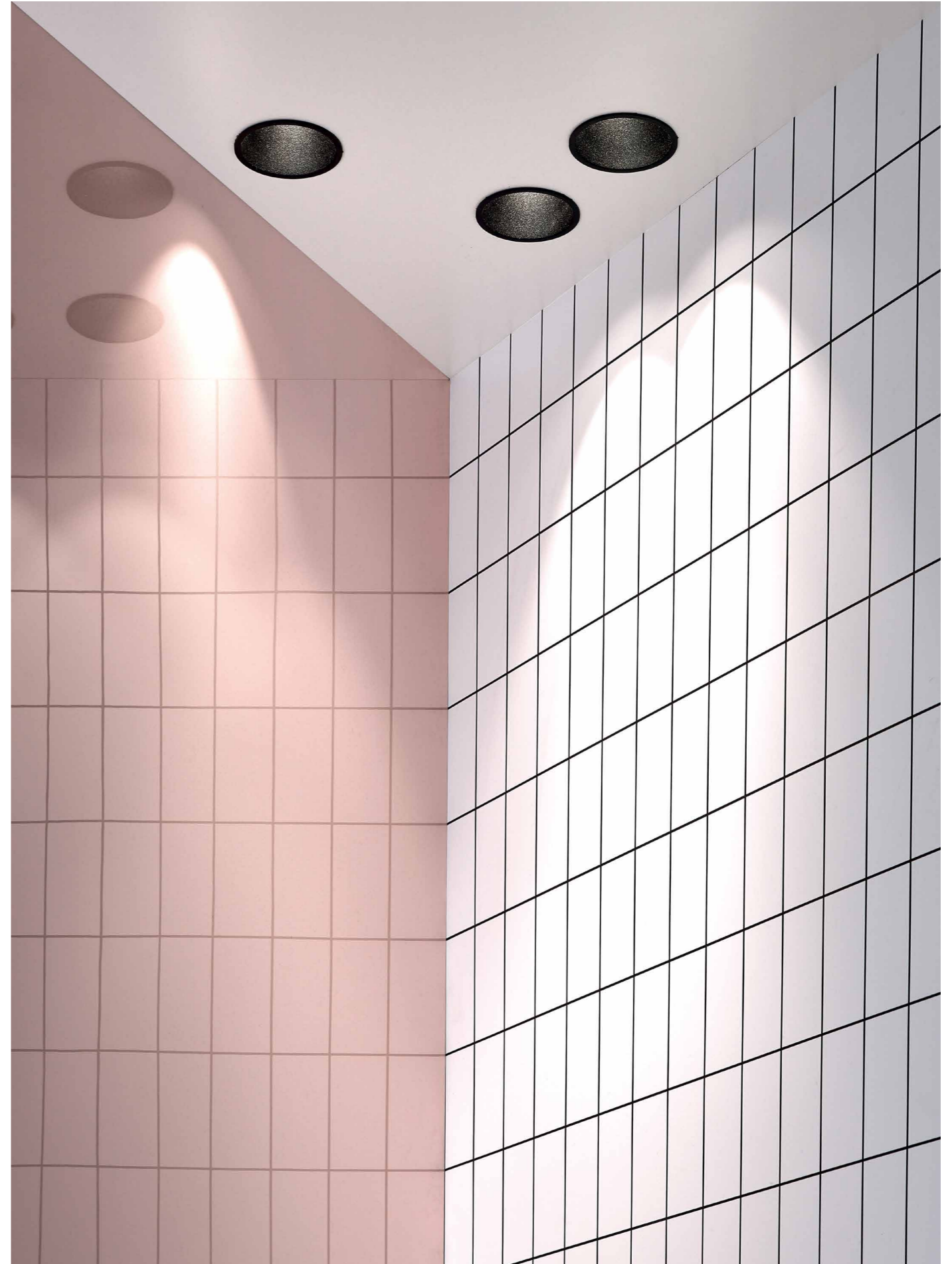





SPLITBOX 2 B + 2 x SPLITBOX SPY B + SPY TUBE B

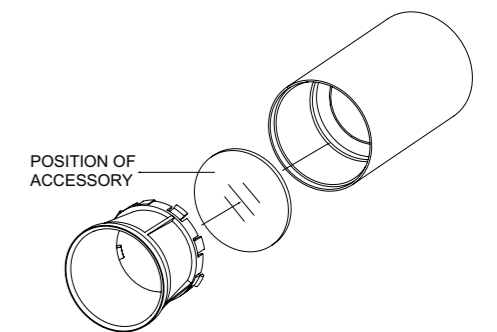



**MIDISPY** led

JAC

PAG 32-33





**SPY JAC** led

/ HP

PAG 34-35





**SPY** led

CLIP HI / ON HI

PAG 36-37





# PINTOR ON led

63 / 90

PAG 38-39



PINTOR 2 ON 63



PINTOR ON 90



PINTOR 1 ON 63



# **SUPER OH!** led SBL TRIMLESS

PAG 42-43





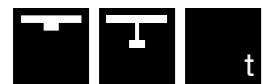

# SUPER OH! XS <sup>led</sup>

## PIVOT / PIVOT AD / C

PAG 44-45



SUPER OH! XS PIVOT AD



SUPER OH! XS PIVOT



SUPER OH! XS



SUPER OH! XS C



# SUPER OH! SBL led

## / DOWN-UP

PAG 46-47

Delta Light® introduces **Wireless Control Dimming**, enabling you to control and manage a selection of LED luminaires via mobile devices. (PAG TEC 12-13)

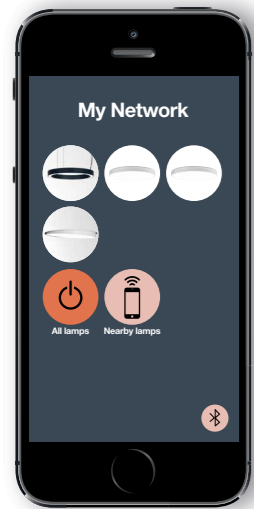

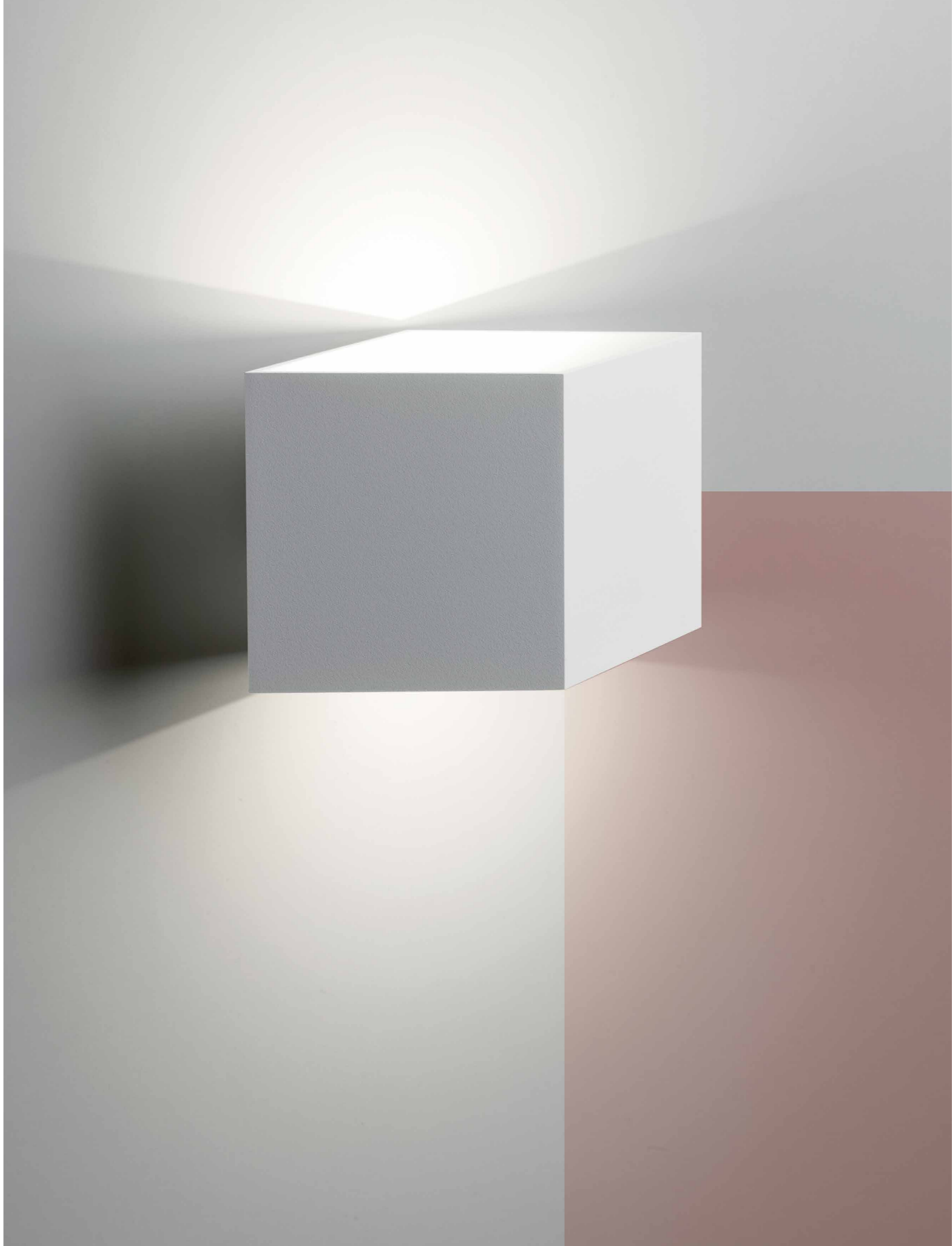

**FIFTY**  
LED

PAG 56-57

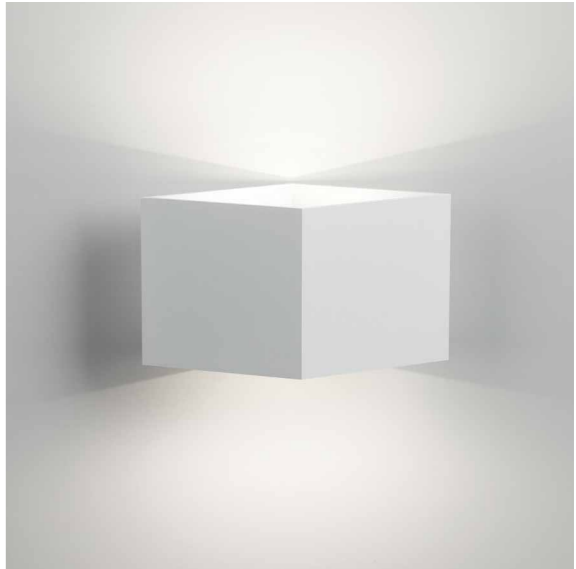



# ORBIT led

## LED

PAG 54-55





**WINCE** led

100 / 160 / 160 DOWN-UP

PAG 62-63



WINCE 100

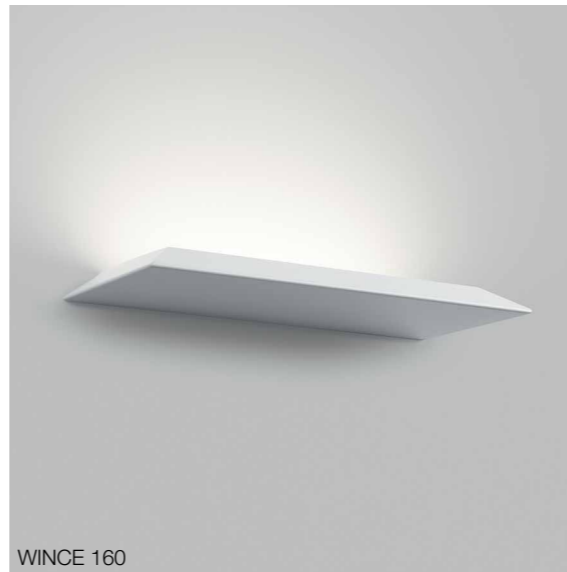

WINCE 160



WINCE 160 DOWN-UP





# TIGA IN led LED

PAG 58-59



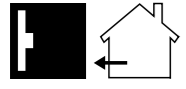

**WANT-IT** led  
S / S X / L

PAG 60-61

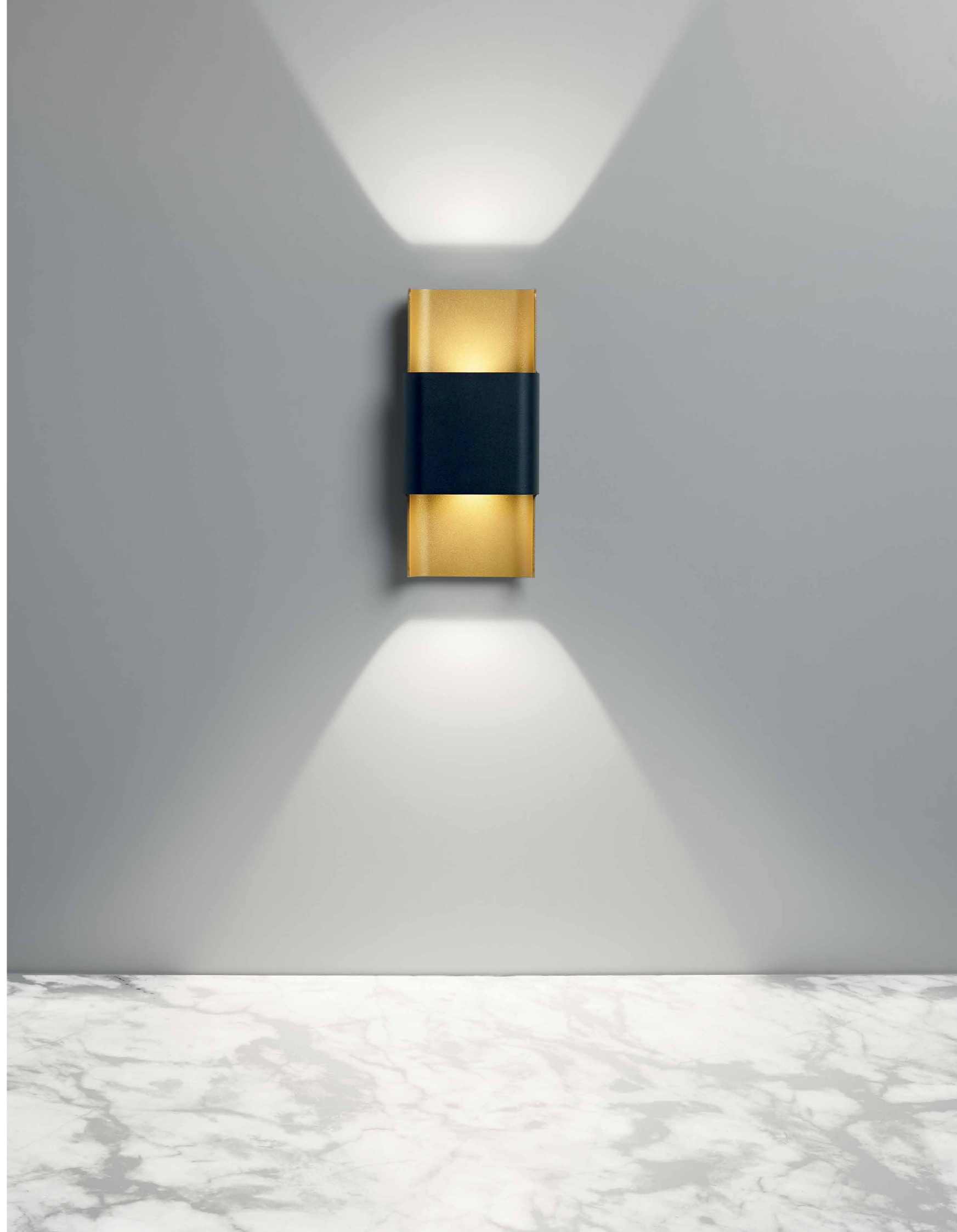



**SPLITLINE 16**   
+ MICRO SPY 27 / 39  
+ LEDLINE 15

PAG 68-73



SPLITLINE 16 + MICRO SPY 27

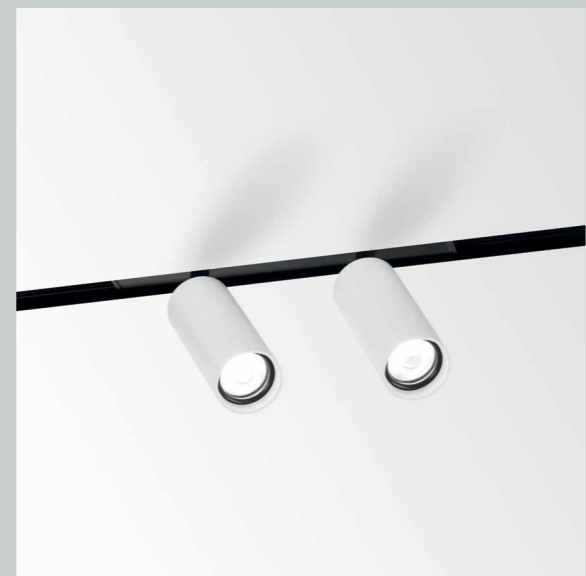

SPLITLINE 16 + MICRO SPY 39







# STREAMLINER <sup>led</sup>

TR / 85 / 70S / 70L

PAG 92-99

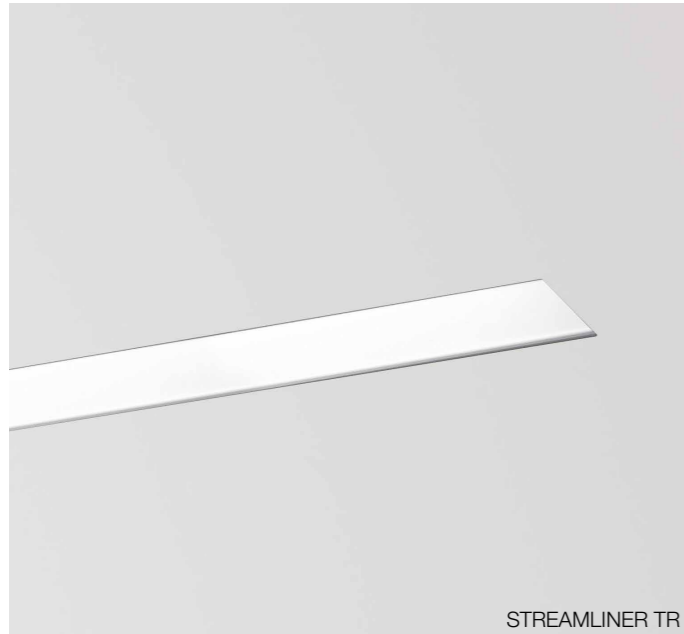

STREAMLINER TR



STREAMLINER 70S



STREAMLINER 85



STREAMLINER 70L



STREAMLINER M10



MIDI SPY M10



SPY M10



SPY HP M10



# SPLIT-IT PRO

PAG 74-91

The new **Split-it PRO** enables integration of edgeless lighting paths, either vertically or horizontally. Its 37° degree sharp edge gives walls and ceilings a 'paper-thin' appearance, with no visible wires and no shadow gaps, upgrading the level of architectural detail. It offers not only new ways to give shape to any lighting need, it also gives the possibility to integrate other engineering and technological necessities.

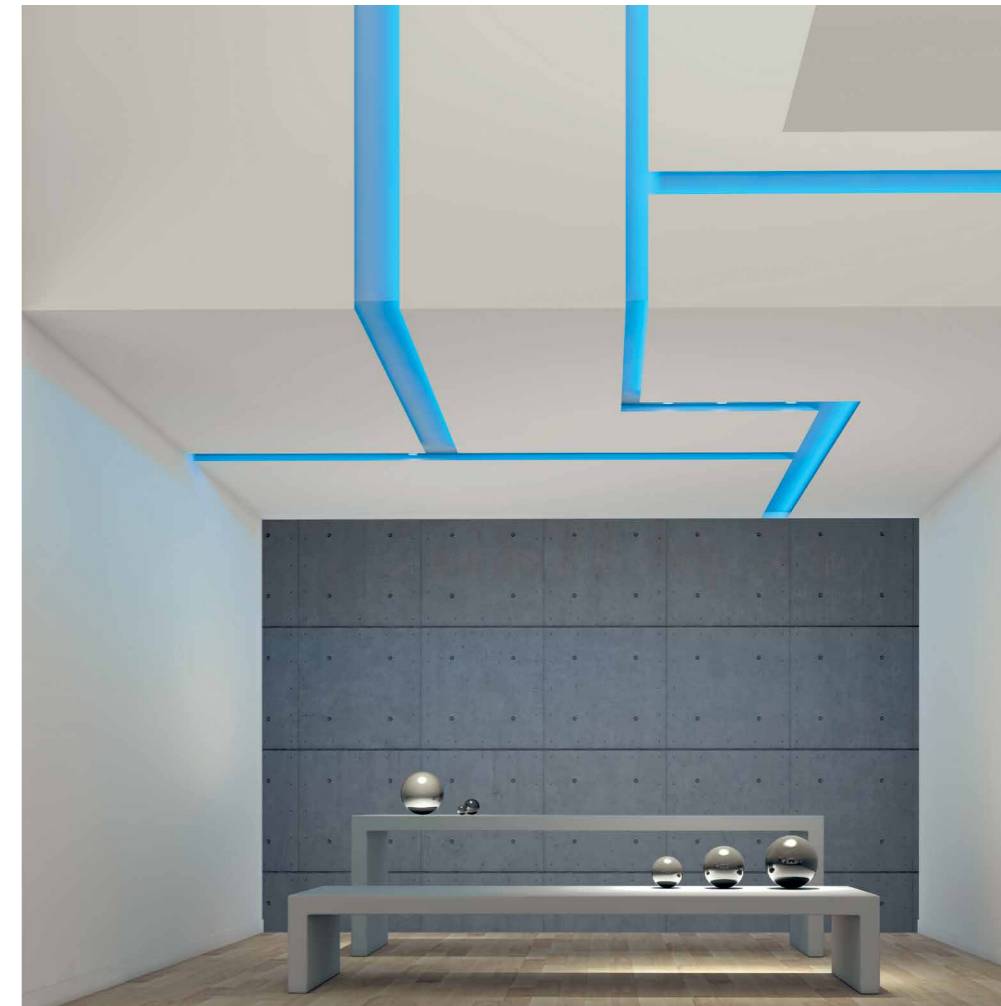
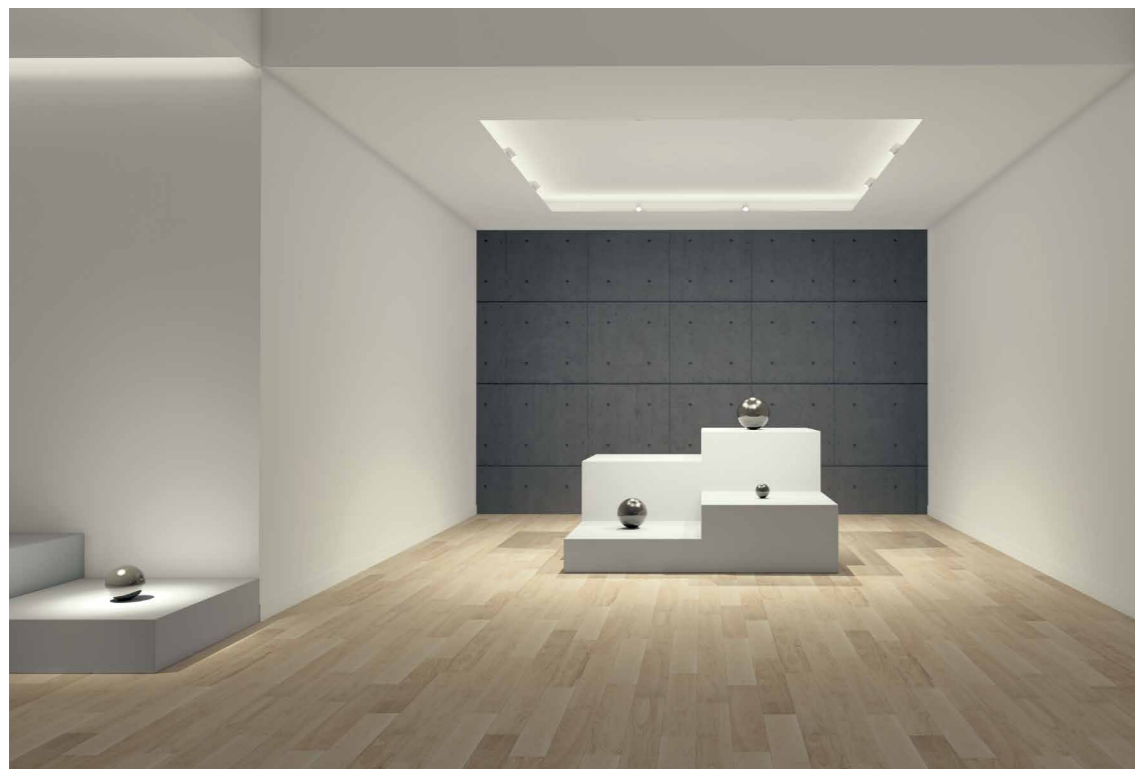
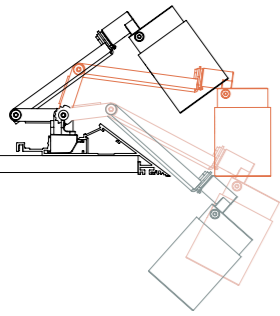



SPLIT-IT RB111



SPLIT-IT SPY



SPLIT-IT PINTOR 63



SPLIT-IT PRO





# SPLIT-IT ON

PAG 74-91

This surface mounted version opens up a new world of lighting scenarios for spaces with demanding lighting needs and ceiling limitations. Be it retail, meeting rooms, circulation areas, public buildings or other, the **Split-it On** caters for any lighting scenario you have in mind, without compromising the elegance and style of your project.

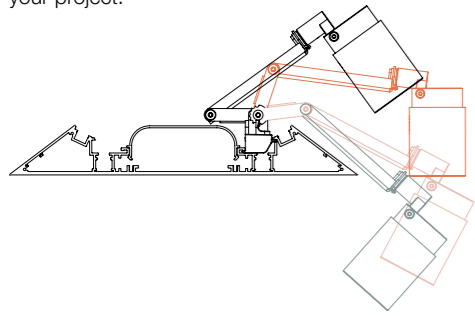

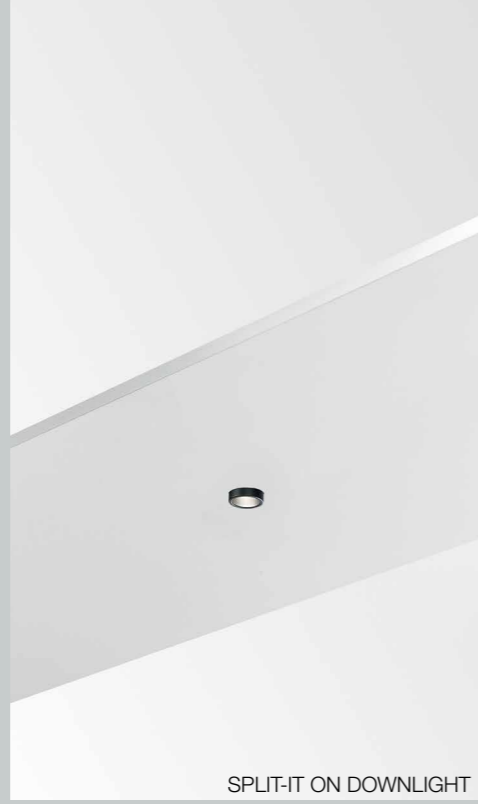

SPLIT-IT ON DOWNLIGHT



SPLIT-IT RB50



SPLIT-IT PINTOR 90



SPLIT-IT ON





# BUTLER BY ARIK LEVY

and Delta Light®



**Arik Levy is an artist, technician, photographer, designer, video artist... his skills are multi-disciplinary and his work can be seen in prestigious galleries and museums worldwide. The Butler is the first design by Arik for Delta Light®.**

The fine line between the indoor territory and outdoors today is blurrier than ever. Furniture and indoor living elements are drifting outdoors in style and function. The experience, comfort and style of our living room is extended to our garden.

The inspiration for this **New Collection** was a coincidence of different elements, and a physical metaphor. On one hand it's a re-interpretation of a well-known archetype, the most obvious classic lamp shade as we know it for many many years. The coincidental element came from Arik cycling through Paris years ago, passing by a big pile of folded paper, used to create the well-known plissé fashion classics.

While its zig-zag shape recalls the past, it also creates a unique play of light. During the day the natural light enhances its form and creates shadow all around the shade... at night the light emitted casts a cozy and intimate light wherever the Butler is installed.

The Butler Wall comes in both interior and exterior versions, single or double, down and down-up. The outdoor bollards come in different heights and two pole sizes, again with a down or down-up light effect.

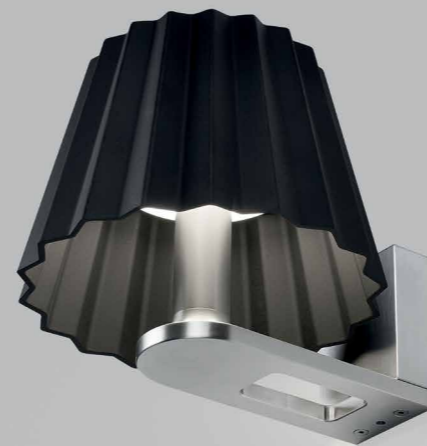



# BUTLER W <sup>led</sup> / DOWN-UP

PAG 108-109



BUTLER W



BUTLER W DOWN-UP



BUTLER W D



BUTLER W D DOWN-UP





**BUTLER P** led

30

PAG 110-111







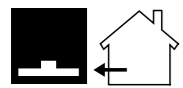

# BUTLER P led

80

PAG 112-113





design by Arik Levy  
[www.deltalight.com/butlerbyariklevy](http://www.deltalight.com/butlerbyariklevy)





